

GENPack

(Order Code KW-GP)

What's Included

- GENPack Housing (2 halves)
- Magnet
- Drive shaft
- 8-Tooth Gear
- Magnet Bushings (2)
- Nylon Bolts (2)
- Nuts (6)
- Wing Nuts (2)
- Plastic Tubing
- Rectifier
- Alligator clip cord pair (1)
- Red LED* (2)
- Bi-polar LED bulb* (2)
- 28 gauge magnet wire with spool* (1)
- Rubber bands*

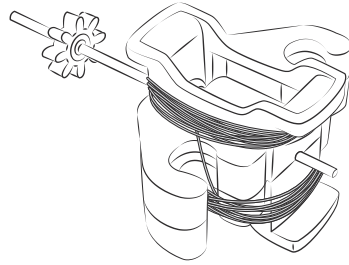

Setting Up The GENPack

Step 1: Assemble the Advanced Wind Experiment Kit

Before you start you will need your assembled Advanced Wind Experiment Kit and the basic tools listed in the materials section.

Step 2: Mount the Magnet to the Driveshaft

Push a magnet bushing onto each end of the magnet† and push them together tightly. You may need to tap them in with a hammer to make them tight.

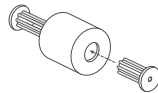

⚠Caution: Strong Magnets

Magnets in this kit should never be placed near people with pacemakers or other medical electronics. Proper operation of pacemakers and other medical devices may be jeopardized by being in close proximity with the strong magnetic field created by this product.

If **two** neodymium supermagnets are in close proximity, it can be easy to pinch your fingers. This can be very painful! Wear safety glasses when working with multiple neodymium magnets, because when two magnets slam together,

they may launch tiny chips at high velocities. We have watched 3/4" magnets accidentally fall together and shatter completely. Neodymium supermagnets larger than 1/4" are **not for unsupervised children**.

It is advised to work on a non metallic surface and keep all tools and metal objects at least two feet away when you are constructing your generator.

Computers, compasses, and onboard electronics may be adversely affected if placed in close proximity with this product. Store this product at least 3 feet from these devices.

Mount the small gear onto one end of the driveshaft. The gear has a very tight fit on the driveshaft. Use a hammer to get it started, if necessary.

Mount the magnet with bushings onto the shaft.

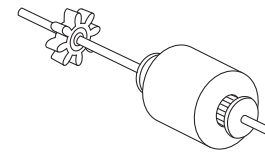
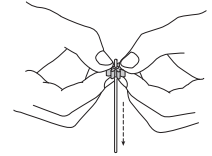

The end without the gear should stick out only about 1/2"—enough that it fits into the nacelle.

Note: The magnet bushing can slip on the shaft at high rates of spin or high torque moments. To reduce this from happening, you can glue the bushings to the shaft as you press them on—a dab of strong glue will be sufficient.

It is important to note that the GENPack magnet has diametrical magnetization, this is different than most ring magnets. When looking for other magnets for this kit make sure that the poles are diametrically magnetized.

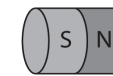

Axially magnetized

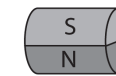

Diametrically magnetized

ⓁNeodymium Magnet

Neodymium magnets are the strongest permanent magnets available (also known as NdFeB, NIB, or Neo magnet). Neodymium magnets are a type of rare-earth magnet made from an alloy of neodymium, iron, and boron to form the $Nd_2Fe_{14}B$ tetragonal crystalline structure.

Neodymium magnets can be found in products such as microphones, professional loudspeakers, in-ear headphones, guitar and bass guitar pick-ups, and computer hard disks where low mass, small volume, or strong magnetic fields are required. Because of their high magnetic-flux, they are also often used in the electric motors of hybrid automobiles and in the electricity generators of commercial wind turbine generators.

*This part is a consumable and is excluded from the warranty.

†Your kit comes with a neodymium magnet that is 0.75" long x 0.75" wide. You could try to use magnets of other sizes and strengths.

Step 3: Install the Magnet Drivetrain into the GENPack Housing

Place the magnet drivetrain into the grooves of one coil housing. Note which direction the gear end of the shaft faces. It needs to be facing out when you install the housing into the Advanced Wind Experiment Kit.

Place the other coil housing piece on top of the plastic base piece.

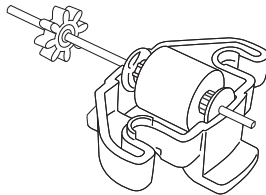

Secure the two plastic pieces together using masking tape, duct tape or rubber bands in order to hold the module together while you wind the coils.

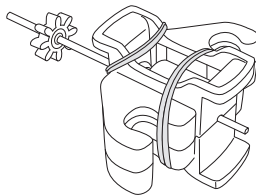

Step 4: Wind the GENPack Coils

Start winding the wire onto the bottom plastic piece, leaving about 1 ft of wire hanging free.

Wind about 150 turns onto the bottom piece and then continuing winding onto the top piece. Wind another 150 turns onto the top piece.

The coils should be connected and wrapped in the same direction. When you are winding, make sure that the wire does not cover the bolt channels.

► Winding coils

It is important that your coils are wound in the same direction or else when you run the GENPack the output from one coil can cancel the other coil out. We have helpful videos on this at www.KidWind.org/videos

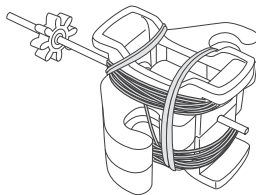

Use a small piece of tape to secure the last winding in place. Cut the wire to leave about two feet of wire at the end.

Using sandpaper, or sharp knife, scrape the insulation off the ends of the wire. You will want about one inch of un-insulated wire on each end so you can connect wire leads with alligator clamps.

► Tips for wiring the generator

The best way is to wire with one continuous piece of wire. Start on the bottom, winding about 150 revolutions, lead the wire up to the top, and, *winding in the same direction* (i.e., clockwise as viewed from above), wind about 150 revolutions on the top. Leave a length of about 1 ft of wire at each end.

Note: Your kit comes with 400 feet of 28 gauge magnet wire. Changing the numbers of turns on your coils and the size of your magnet wire can dramatically affect electrical output and torque requirement of the generator. We recommend 24–32 gauge wire. If you make 150 turns of 28 gauge wire on the GENPack, you need about 60 feet of wire.

Step 5: Advanced Wind Experiment Kit Head Modifications

Replace two of the steel bolts on the Advanced Wind Experiment Kit with the nylon rods. The nylon rods are not magnetic, so they will not interfere with the neodymium magnet in your new generator.

You will also want to install two ½" pieces of tubing on each of the nylon rods before you install on the Advanced Wind Experiment Kit. These will help to hold the GENPack solidly while buffering the generator from vibrations of the moving turbine.



Step 6: Mount the GENPack in the Advanced Wind Experiment Kit

Mount your GENPack module on the nylon rods so that the gear on the generator meshes with the larger gear of the turbine shaft.

Adjust the height so that the two gears mesh fully, but not so close that they bind.

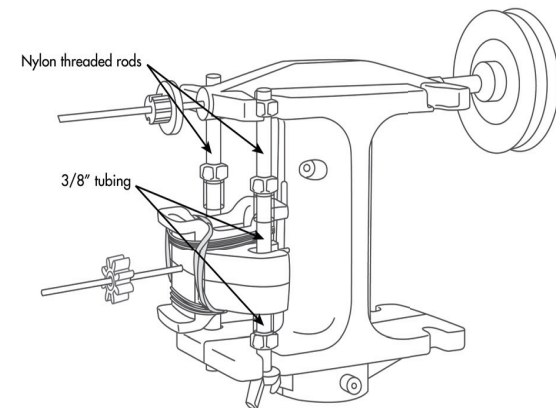

► Check online for help!

For help with assembling the GENPack, visit www.vernier.com

Simple Generator Theory

To help you experiment with your GENPack, it is helpful to understand the basic physics that govern the functioning of a generator. If you are inclined, you can do additional research to explore each of these topics to a greater (and more complicated) level.

Q: What is happening inside of my GenPack?

A: The GenPack produces voltage and current that is dependent on *magnetic field strength, the number of windings the coil has, how fast the magnet spins, and the proximity of the coils to the magnetic field.* To increase your output you need to make the field spin faster, add more coils, or get stronger magnets.

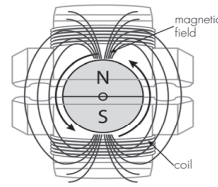

Q: What is the expected output of a GENPack?

A: We have used a GENPack in an Advanced Wind Kit turbine to produce more than 8 V and 0.5 A. The output is highly dependent on how you wind your generator, how fast your fan can blow, and how well you make your blades.

① How to increase GENPack Output

1. More turns of wire
2. Spin the magnet faster
3. Use a stronger magnet
4. Use a bigger magnet

Q: What should happen if I change the number of windings on each coil?

A: The voltage is proportional to the number of windings multiplied by the size and the rate at which the magnetic field changes. So more windings gives higher voltage, and fewer windings gives lower voltage.

Here is a simple equation showing the relationship between number of coil windings, magnetic flux, and speed of the spinning magnet in your GENPack.

$$Voltage = N \times \frac{\Delta(BA)}{\Delta(T)}$$

N = Number of Turns of Magnet Wire

B = Magnetic Field (teslas)

A = Area of Magnetic Field (m²)

T = Time (s)

Q: What should happen if I change the strength of the magnet?

A: Again, the voltage is proportional to the number of windings times the rate at which the magnetic field changes. So (as long as the magnet is rotated at the same speed), a stronger magnet produces a stronger magnetic field change which means higher voltage.

Q: What happens when I change the size of the magnet wire?

A: If the number of windings remains the same, changing the size of the wire does not affect the voltage. (Exception: If the wire size gets big enough that the coils get spaced farther away from the magnetic field, then the voltage goes down.) The main advantage of larger wire diameter is that there is less resistance in the wires, so the amperage and voltage will not drop as much by the resistance of the wire itself.

With smaller diameter magnet wire you can fit more turns in a smaller space closer to the magnetic flux. This could possibly increase your voltage. But the current

moving through the smaller wires will meet more resistance and start to heat up the coil and reduce efficiency.

Q: What should happen if I make the generator spin faster?

A: The electromotive force is proportional to how fast the magnetic flux changes: So spinning the generator faster changes the magnetic flux faster and provides a higher voltage.

Q: Why is there resistance to spinning when I have a load in the circuit?

A: Resistance in the circuit means the generator is powering something. If you get power out of the system, you must put power into the system.

The “power-in” multiplied by the “generator-efficiency” equals the “power-out.” So, if you want to power a one-watt load, and the generator efficiency is 40% (0.4), then you must input 2.5 watts mechanical power.

Q: How is this AC generator different than the DC one that comes standard in the Advanced Wind Experiment Kit Kit.

A: The DC generator (also a DC motor) has the wire coils rotating inside the magnets. It also has brushes/split rings that turn what would have been AC into pulsed DC. For more info on this see the Electricity Section.

Q: What if I wind the top separately and the bottom separately?

A: If you connect a multimeter to only one of the coils (either one), you will get only about half the voltage that a full winding of top-and-bottom yields.

If you have wound the coils separately, you can still get full voltage if you correctly connect the two coils together: Connect the wire coming out of the bottom coil to the wire going into the top coil. Now they act as one continuous coil, just as if you had wired them with one continuous piece of wire (as long as they were both wound the same direction, i.e., clockwise, as viewed from above). If you incorrectly connect the two coils, they will oppose each other and your output will be approximately 0 V.

Q: What if I separately wind the bottom coil clockwise, and separately wind the top coil counter-clockwise (as viewed from above)?

A. Once again, a great science project if you have an oscilloscope. Or use a multimeter in a pinch. You can use either coil separately and get about one-half the full voltage. Connect the wire-out of the bottom coil to the wire-out of the top coil (since it is wound in the opposite direction). Now they will act as a continuous piece of wire wound in the same direction and deliver full voltage.

Q: How do I get direct current from my GENPack?

Using the provided rectifier will allow you to obtain direct current (DC) from the GENPack. Wire the GENPack’s two leads to the two center leads of the rectifier. The output terminals from the rectifier are labeled + and –, which may be connected to DC loads.

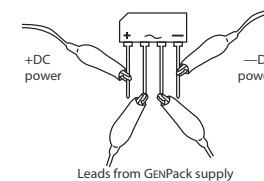

If you use the red LED, you will notice that it lights with one polarity of wiring, but not the other polarity (since LEDs only allow current to flow in one direction). If you hook up the red/green LED, one color will light for each polarity of wiring.

Using the Electrical Output of the GENPack

Unlike the direct current (DC) motor that came in your Advanced Wind Experiment Kit, the GENPack produces alternating current (AC).

To test if your GENPack is working, use wire leads to connect the generator wires to a multimeter. Set the multimeter to AC voltage.

If your meter shows you are getting some output, then your system is set up correctly.

Conditioning and Using Power

The rectifier included in the GENPack kit is a simple item that will convert the alternating current (AC) to direct current (DC). Once you are generating DC you can hook the GENPack to the water pump, power output board, fuel cells, or other devices.

To wire the GENPack to the rectifier, connect the leads from the GENPack to the center two pins of the rectifier. The outer two pins of the rectifier are the positive and negative DC output pins.

Collecting GENPack Data with an Oscilloscope

To get more insight into how your generator is working, you can hook your GENPack module to a simple two-channel oscilloscope.

We have used a simple USB oscilloscope from Parallax that works well to examine output characteristics such as frequency and voltage.

We have also used Vernier data-collection software to obtain more complete data on output performance. Information about how Vernier data-collection tools can be used, visit <http://challenge.kidwind.org/online/performance-testing>

① Why do the lights flicker?

The GENPack produces alternating current (AC) as the magnet spins around near the coils. If you wire the output to the red LED, you will see a pulsing light (this is because LEDs only accept one direction of current flow). If you can count very quickly, you may be able to count the LED light pulses and determine the frequency of the AC being generated.

Try connecting the red/green LED. The red will light when current flows in one direction; the green will light when the current flows in the other direction.

Troubleshooting

1. Check the direction of your coils.
2. Have you removed the enamel from the wires completely?

More Information

Check out these websites for more information.

www.animations.physics.unsw.edu.au/jw/electricmotors.html

www.en.wikipedia.org/wiki/Electrical_generator

www.en.wikipedia.org/wiki/Maxwell's_equations

www.allaboutcircuits.com/worksheets/acgen.html

www.micro.magnet.fsu.edu/electromag/electricity/generators/index.html

Additional Resources

For more information about wind energy, see KidWind's document, *Learn Wind*, available at http://learn.kidwind.org/sites/default/files/learn_wind.pdf

NOTE: Vernier products are designed for educational use. Our products are not designed nor recommended for any industrial, medical, or commercial process such as life support, patient diagnosis, control of a manufacturing process, or industrial testing of any kind.

Warranty

This kit contains many parts. Parts in the kit, excluding consumables, are warranted for a period of five years. Consumables are clearly marked on Page 1 of the user manual.

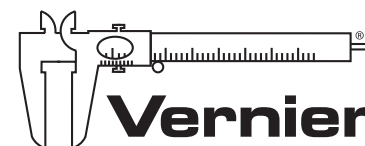

MEASURE. ANALYZE. LEARN.™

Vernier Software & Technology

13979 SW Millikan Way • Beaverton, OR 97005-2886

Toll Free (888) 837-6437 • (503) 277-2299 • FAX (503) 277-2440

info@vernier.com • www.vernier.com

Rev. 7/8/2015

Vernier and caliper design are our registered trademarks. Vernier Software & Technology and vernier.com are our trademarks or trade dress.

The KidWind Project and KidWind are trademarks of The KidWind Project in the U.S. or other jurisdictions.



Printed on recycled paper.