

About KidWind

The KidWind Project is a team of teachers, students, engineers, and practitioners exploring the science behind wind energy in classrooms around the US. Our goal is to introduce as many people as possible to the elegance of renewable energy through hands-on science activities which are challenging, engaging, and teach basic science principles.

While improving science education is our main goal, we also aim to help schools become important resources for both students and the general public, to learn about and see renewable energy in action.

Thanks to ...

We would like to thank the Wright Center for Science Education at Tufts University for giving us the time and space to develop this idea into a useful project for thousands of teachers. Over the last 10 years we have trained over 8000 teachers who impact more than 600,000 students annually.

We would also like to thank Trudy Forsyth at the National Wind Technology Center and Richard Michaud at the Boston Office of the Department of Energy for having the vision and foresight to help establish the KidWind Project in 2004. Lastly, we would like to thank all the teachers for their keen insight and feedback on making our kits and materials first rate!

Wind for All

At KidWind, we strongly believe that K–12 education is an important foundation for promoting a more robust understanding of the opportunities and challenges that emerging clean energy technologies present.

Our Adopt-a-School program seeks to support teachers and students all over the globe who do not have the financial capacity to access our training programs and equipment. We believe that all teachers and students—regardless of where they live or what school they attend—must be part of the clean energy future. <http://learn.kidwind.org/adopt-a-school>

A Note on Reproduction

This work may not be reproduced by mechanical or electronic means without written permission from KidWind, except for educational uses by teachers in a classroom situation or a teacher training workshop. For permission to copy portions or all of this material for other purposes, such as for inclusion in other documents, please contact Michael Arquin at KidWind: michael@KidWind.org

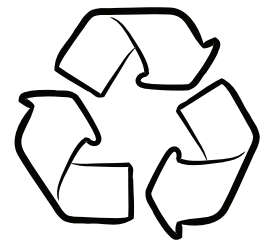

Our plastic components are made from recycled resins.



Made in US

We source domestically whenever possible, and assemble and pack our kits in St. Paul, MN.

We Give Back 

Proceeds from your purchase help us train and supply teachers.

simpleGEN Parts List

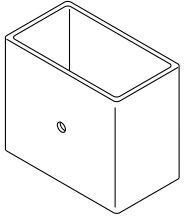

Housing (2)

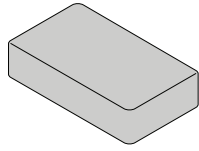

Ceramic magnets (4)

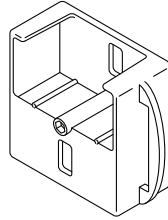

Magnet holder (1)

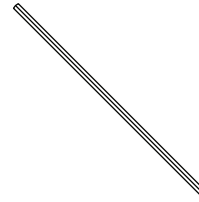

Driveshaft (1)

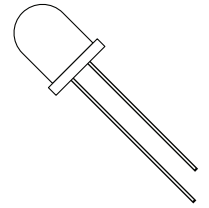

Red LED (1)

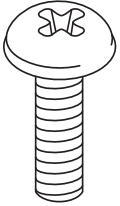

Screws (3)

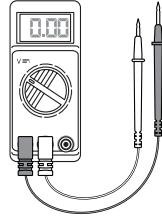

Multimeter (1)

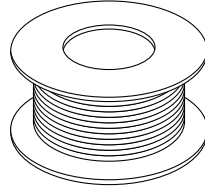

28-gauge magnet wire (150 m)



Springs (2)

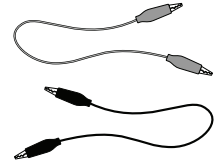

Alligator clip cord pair (1)

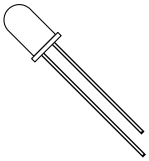

Bicolor LED (1)

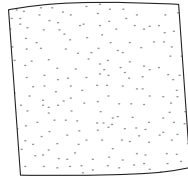

Sandpaper (1)

Tools you may need:

Scissors

Electrical tape or duct tape

Drill

Replacement and upgrade parts:

H0091 28-gauge magnet wire

H0176-04 Ceramic magnets 4 pack

H0176-40 Ceramic magnets 40 pack

H0240-2 simpleGEN housing

You can find all of these parts in the KidWind store at www.KidWind.org

About the simpleGEN

Working with students, we have built many different kinds of small generators. The KidWind simpleGEN is based on a design that we loved by William Beatty called the *Ultra-Simple Electric Generator* (<http://www.amasci.com/amateur/coilgen.html>). In our design, we have changed some of the parts to make it easier to build, and to last longer.

All wind turbines contain generators that transform the energy of the wind into electricity. Engineers are constantly trying to improve the performance of these generators, allowing the turbines to transform more wind energy into electricity. This kit will allow you to explore how a simple generator works.



CHECK OUT ONLINE VIDEOS FOR HELP!

For further help with assembling the simpleGEN, watch a quick video at www.KidWind.org/videos

With the simpleGEN, students will explore concepts such as:

- Understanding the main parts of an electrical generator
- Understanding the relationships between the main parts of an electrical generator
- Constructing a simple generator
- Understanding how electricity is generated
- Using a digital multimeter to record AC voltage

1 ASSEMBLY: MAGNETS

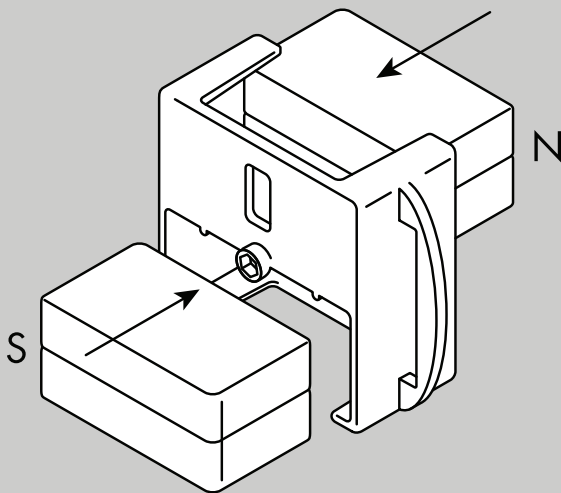

Connect two ceramic magnets together and insert them into the top of the magnet holder. Take the other two and insert them into the bottom of the holder.

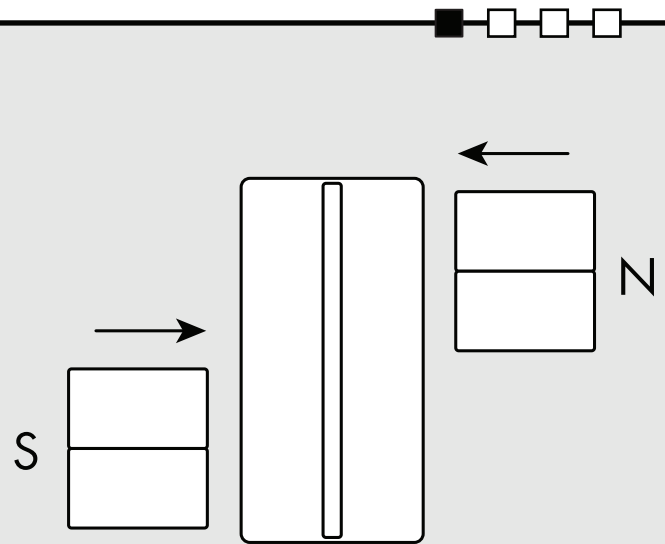

In order for the generator to work properly, opposite fields need to be facing outwards: north on one side, south on the other. As you assemble, you will feel the flux fields (p. 15) of the magnets forcing the magnets into proper alignment.

2 ASSEMBLY: WIRES

Determine how many turns of wire you will wrap around your box. Each turn will use approximately 30 cm of wire. The spool of wire included in the simpleGEN kit has 150 meters of wire, which offers you a maximum of 500 turns in total. As two housings are provided in this kit, you could make two generators with different numbers of coils.

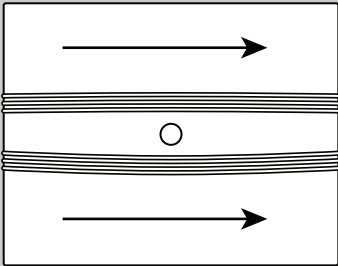

Wrap the wire neatly around the top and bottom of the hole in which the drivetrain will be inserted. Wrap the top and bottom coils in the same direction.

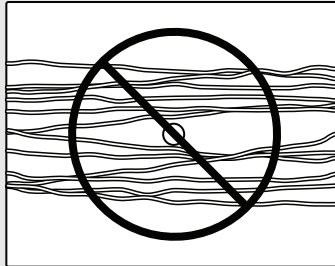

Be sure that you have wound your coils very neatly. They should be straight, not crooked, and fit tightly around the housing.

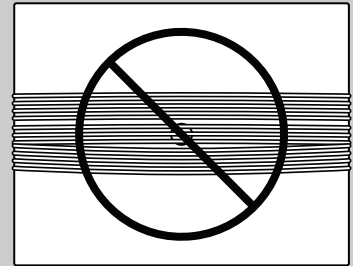

Do not cover up the hole in the box. This is where you will insert the drivetrain.

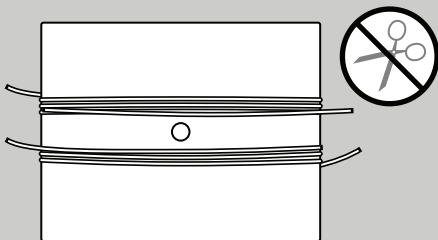

Do not cut the wire connecting the top and bottom coils.

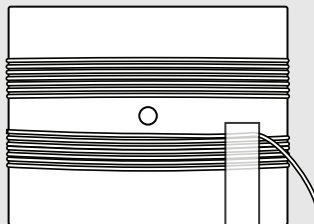

When you have finished wrapping the wire, tape your coils in place.

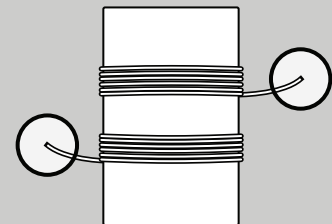

Make sure to leave two leads extended from the box.

3 ASSEMBLY: SPIN

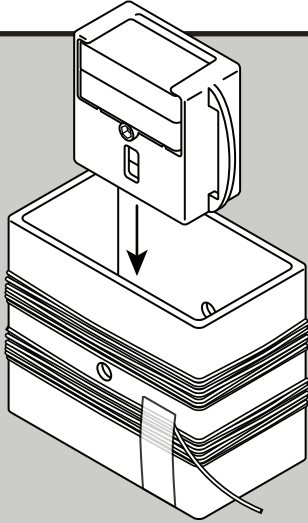

Insert the magnet holder with magnets into the generator box.

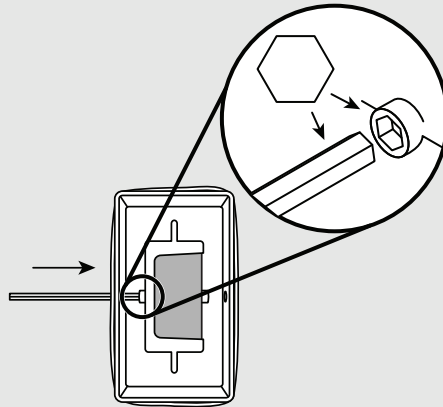

Align the hex driveshaft with the magnet holder's center hole and insert.

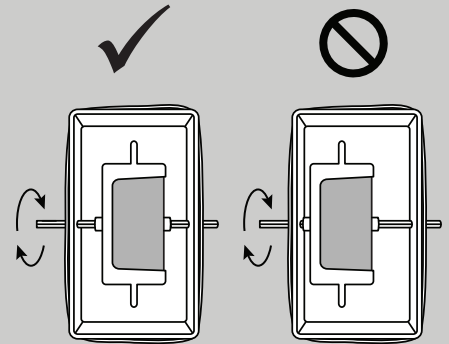

Make sure that the magnet holder is centered in the generator box when it is spinning.

4 ASSEMBLY: ELECTRICITY

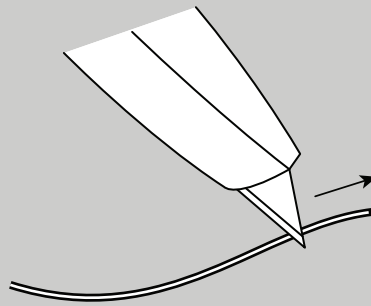
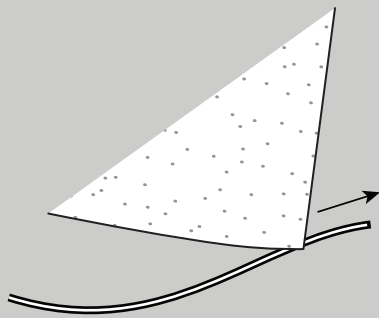

Magnet wire is covered with a thin coat of enamel. To reach the conductive wire beneath, you will need to use sandpaper or a craft knife to scrape off the enamel coating on the wire from about half an inch from the ends of the leads.

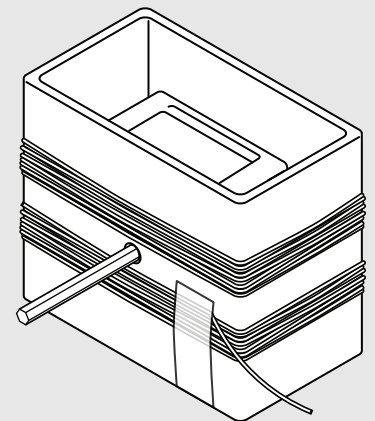

Now you are ready to perform experiments with your simpleGEN!

TESTING YOUR SIMPLEGEN

To collect output data on how well your generator is performing, you can attach an LED bulb or a digital multimeter to it.

LED

Depending on how many turns of wire or the size of the wire used, you may be able to light up an LED as you spin the generator. You can get a rough idea of how much current or voltage you are generating by seeing if the LED lights up and how brightly it glows.

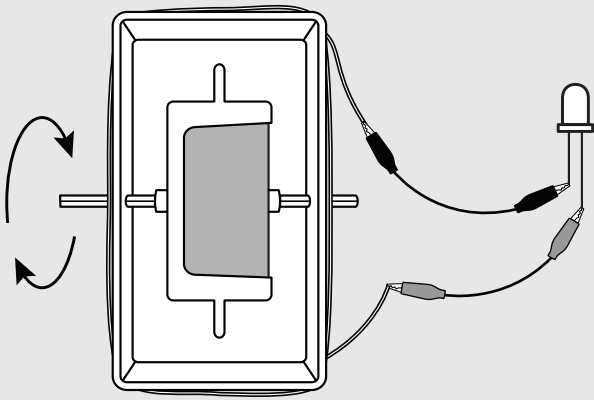

MULTIMETER

Using a simple multimeter set to measure AC voltage, you can collect data on the output of your generator as you conduct comparative experiments.

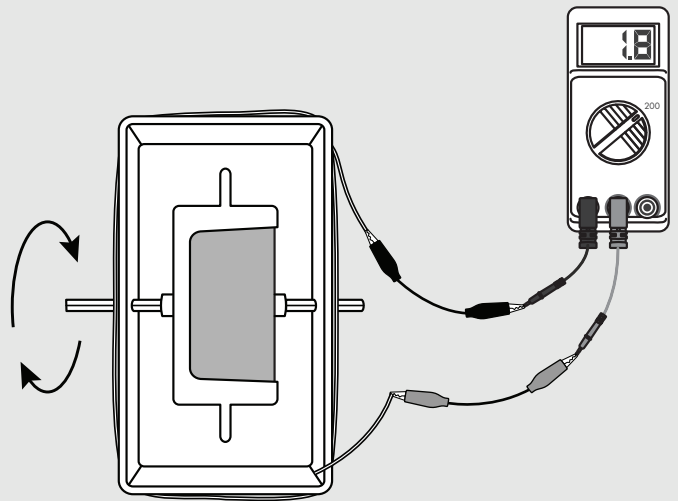

You can use your hands or a drill to spin your generator. For experimental purposes, it is better to use a drill so you can maintain a constant speed over a longer period of time.

HAND SPINNING

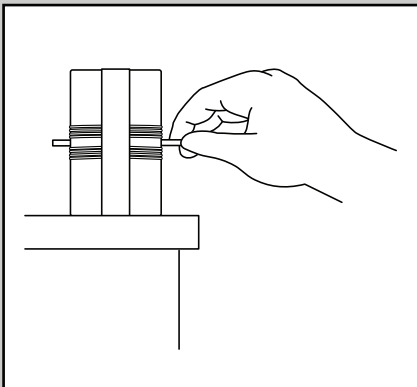

DRILL SPINNING

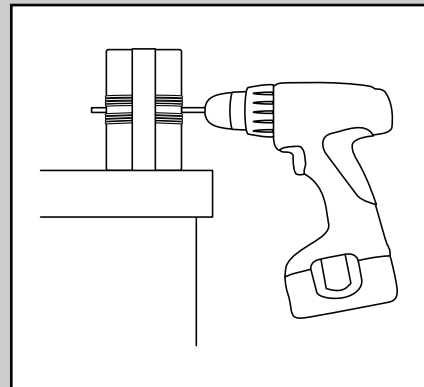

TROUBLESHOOTING YOUR SIMPLEGEN

Q Why isn't my generator spinning?

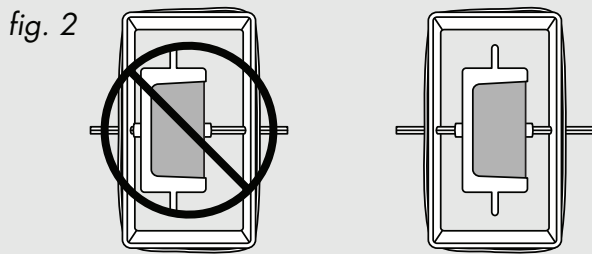
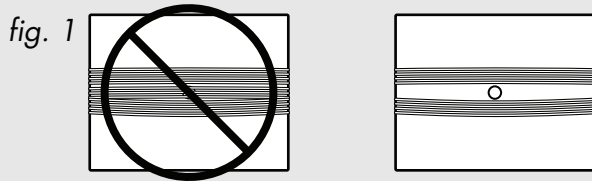

A Make sure that no wire is covering the hole on the box for the driveshaft (fig 1).
Make sure the magnet holder is centered in the box (fig 2).

Q Why aren't I reading any data on my multimeter?

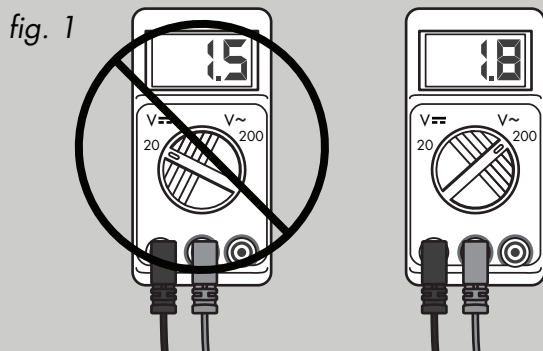

A Did you scrape the enamel off the ends of the magnet wire?
Is the meter set on AC Voltage (fig.1)?
Did you insert your magnets into the magnet holder so that they face north on one side and south on the other?

Q Why isn't the LED lighting up?

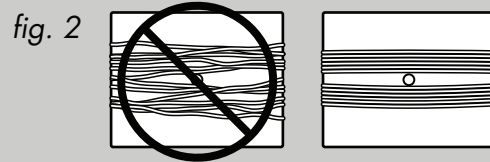
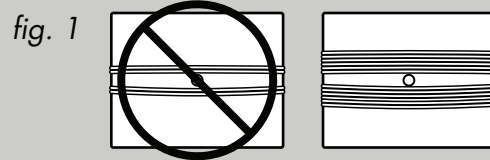

A Make sure that you have wound enough coils around the box. Less than 100 turns in total will not light an LED bulb (fig. 1).

You might need to make the generator spin faster. The voltage you generate is related to how fast the magnetic field changes.

Make sure you have removed the enamel from the ends of the wires or you will not conduct any electricity.

Be sure that you have wound your coils around the simpleGEN box very neatly. They should be straight, not crooked, and fit tightly around the housing (fig. 2).

Q What can I do with my simpleGEN when I am finished using it?

A Try to recycle all the components of the kit. The copper magnet wire is quite valuable to recyclers, so find a recycling center in your area and give them your wire!

The magnets can be used over and over.

Or, instead of recycling the components, you could donate your kit to a teacher who needs a generator for demonstration in his or her classroom!

SIMPLEGEN EXPERIMENTS

Coils

How you wind your coils can affect how well a generator works. Try testing generators with different numbers of turns of wire, different orientations of coils, or different numbers of coils.

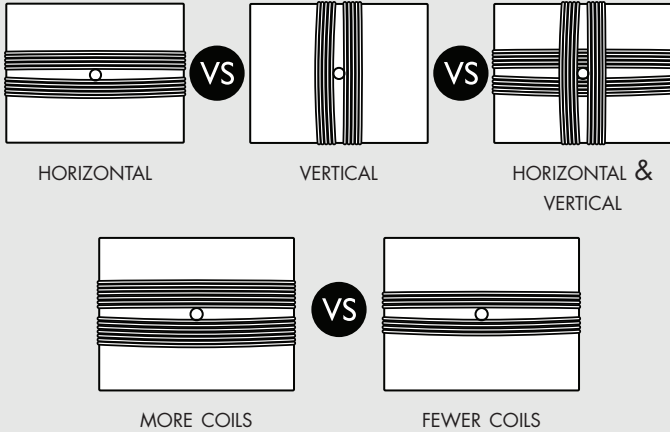

Strength of Magnets (SAFETY!)

You can buy larger neodymium magnets from a number of companies. Look for sizes that will fit into the magnet holder. Use caution as large neodymium magnets are very strong and can cause injury if they snap together with your fingers in between them!

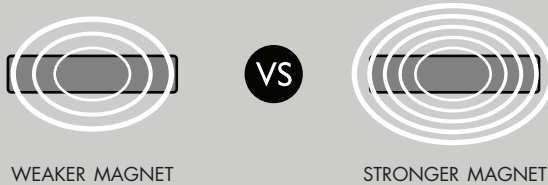

Diameter of Wire

Try wrapping the same number of turns of wire, but using different wire gauges. You can get different sizes of wire at KidWind or any local electronics store. What happens to your voltage output?

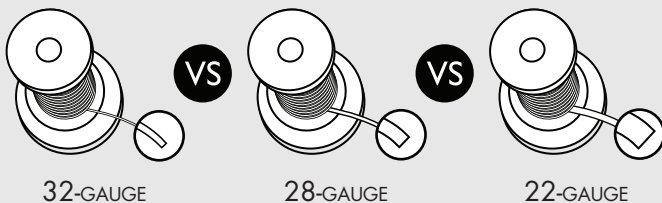

Number of Magnets

On one generator, use only one magnet on each side of the magnet holder. You can do this by making a cardboard shim and substituting it for one of the magnets on each side. How does this affect your voltage output?

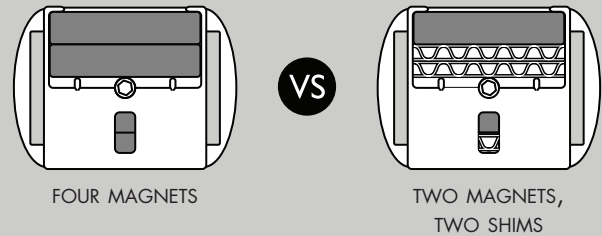

Speed of Spinning

How fast you spin your magnets can affect your voltage output. Try spinning your generator at different speeds and see what happens.

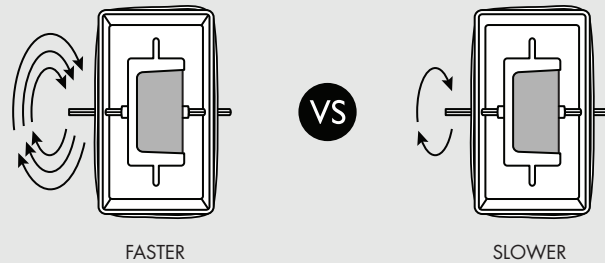

Distance from Magnets to Coils

We have provided a simple box that you can wind your coils around. If you want to get creative, you could build your own box so that the coils are closer to the magnets. This can greatly improve the performance of your generator.

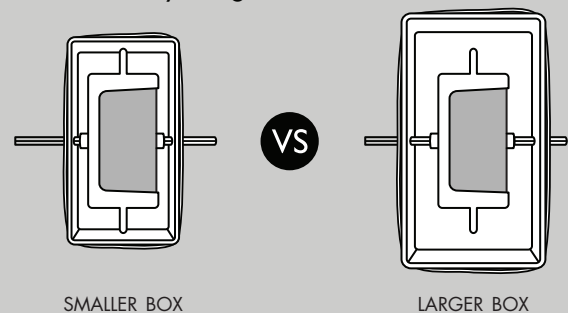

Understanding your simpleGen

Adapted from William Beatty's description (<http://www.amasci.com/amateur/coilgen.html>)

Magnet Wire Coil

All metals have a property called "electric charge." This electrical charge is found in the metallic atoms and is comprised of positively charged protons and negatively charged electrons. Metals are special because their electrons do not stay connected to the atoms in the metal; instead, they can move around inside the metal and form a type of electric "liquid" or current inside the wires. The question is, how can we get this current moving? The answer: by moving magnets!

Magnets & Magnetic Field

Magnetic fields surround magnets. A magnetic field is invisible, but can be felt when you get two magnets near each other or put magnets near other metal objects. The strength of these fields depends on the size, type, shape, and orientation of the magnets.

Whenever a circle of wire surrounds a magnetic field, and we rapidly change the magnetic field, a "pressure" appears. This pressure is called voltage. The faster the magnetic field changes, the higher the pressure—or voltage—generated. This voltage tries to force the "fluid" or current inside the wire to rotate around the circuit.

If the "circle" or circuit of wire is not closed or complete, then the pumping force will cause no charge to flow. Instead, a voltage difference will appear at the ends of the wires. But if the circuit is "complete"—or "closed"—then the magnet's pumping action can force the electrons of the coil to begin flowing. A moving magnet can create an electric current in a closed circuit.

This effect is called electromagnetic induction and was discovered by Michael Faraday. This is a basic law of physics, and it is used by all coil/magnet electric generators.

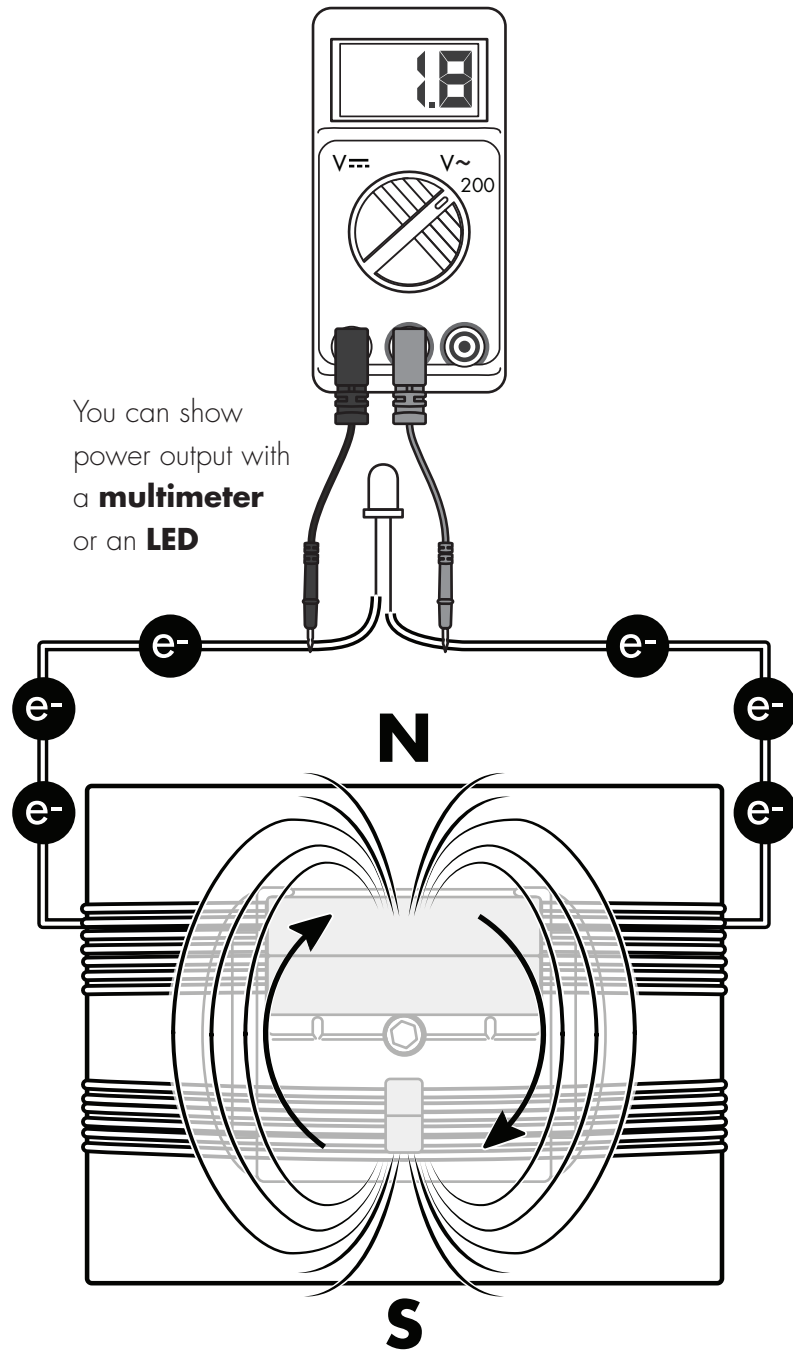

DC Motion

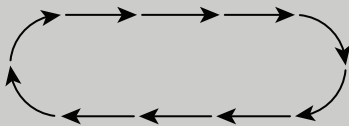

AC Motion

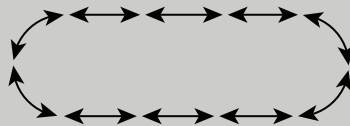

AC Current and DC Current

In a **Direct Current (DC)** circuit, electrons travel in one direction from the negative poles to the positive poles.

Alternating Current (AC) is different. As the magnetic field fluctuates, the electrons are pushed in one direction, and when the field flips they are pushed in the opposite direction. In your house, this flipping happens 60 times per second!

MAKE A SIMPLE MOTOR

You can turn the simpleGEN into a motor with a few changes. To make a motor you need to run electricity through the coils, which will create a magnetic field around the coils that will repel the magnets and make them spin. To get this to work properly, you need to pulse the magnetic field in the coils; otherwise, the magnets will lock up, and the magnet will not move.

Once you have a working motor, you can see how variables such as input voltage, coils, or weight applied affect the performance of the motor.

Additional materials you will need: 9 V battery, and nail polish or tape.

- 1** Drill three $5/32$ " holes in your generator box as shown in the diagram and insert the three screws that come with this kit.
- 2** Put tape or nail polish down the length of the driveshaft, but on one side only. This is the "switch" that pulses the DC voltage.
- 3** Wrap copper wire around the screws indicated on the diagram. Make sure the enamel has been cleaned off the ends of the wire.
- 4** One spring goes over the driveshaft and the screw where the ends of the coils are attached.
- 5** The other spring goes over the covered driveshaft and the screw.
- 6** Attach alligator clip cords to the battery, the copper wire, and the spring.

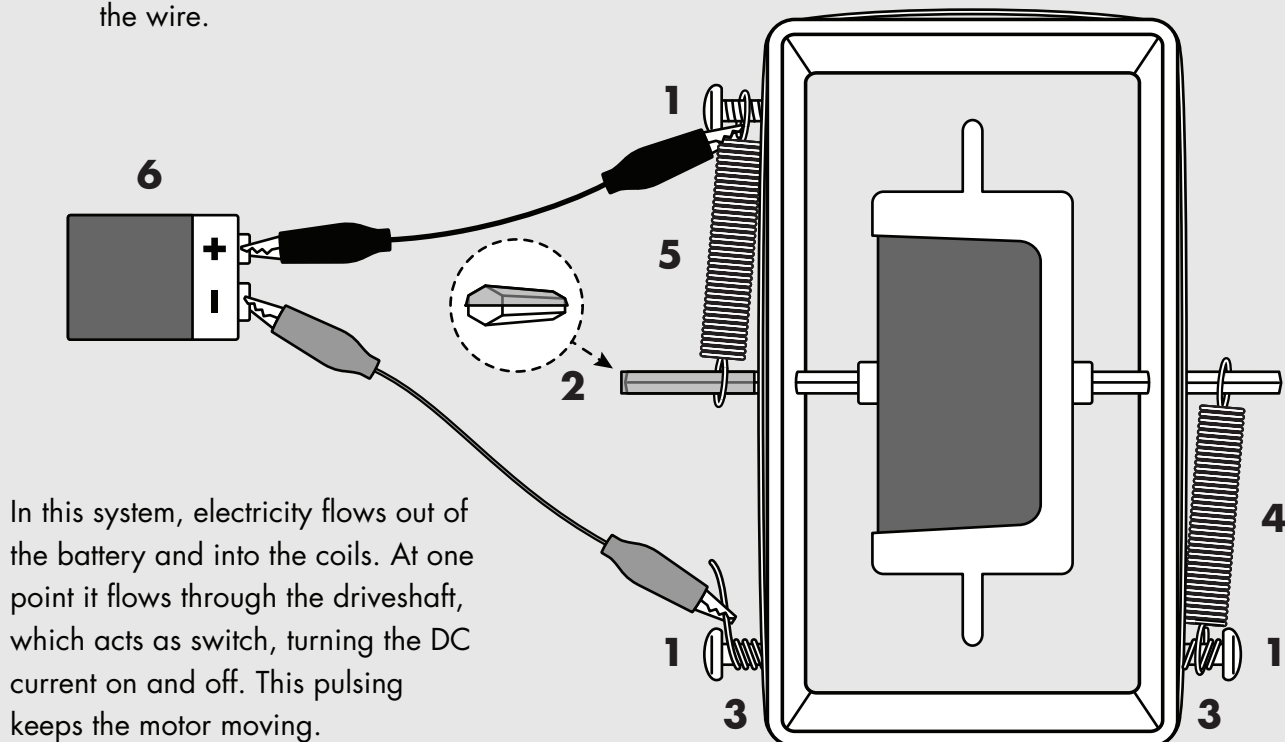

In this system, electricity flows out of the battery and into the coils. At one point it flows through the driveshaft, which acts as switch, turning the DC current on and off. This pulsing keeps the motor moving.

MAKE A SIMPLEGEN WIND TURBINE

Using the simpleGEN Upgrade pack, you can create a simpleGEN Wind Turbine! The upgrade pack comes with everything you need to get started experimenting with wind power, including a drivetrain set (a), a crimping hub (b), blade design materials (c), and dowels (d).

A Drivetrain set

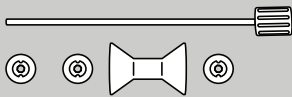

B Crimping hub

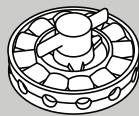

C Blade design materials

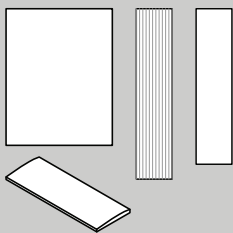

D Dowels

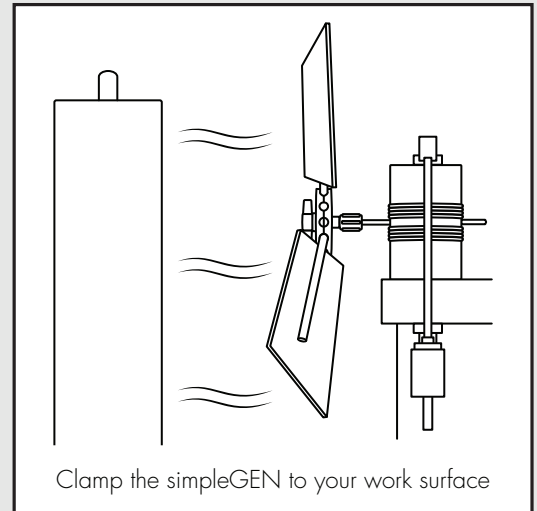

BLADE DESIGN & SAFETY

Having efficient blades is a key part of generating electricity from a wind turbine. It takes time and thoughtful effort to make great blades. As you design, keep a few things in mind:

- More blades will generate more spinning force. If your simpleGEN is not turning, make more blades.
- Pitch is very important as you test your blades.

The Learn Wind document in your simpleGEN Upgrade kit has a lot more information on blades, so check it out!

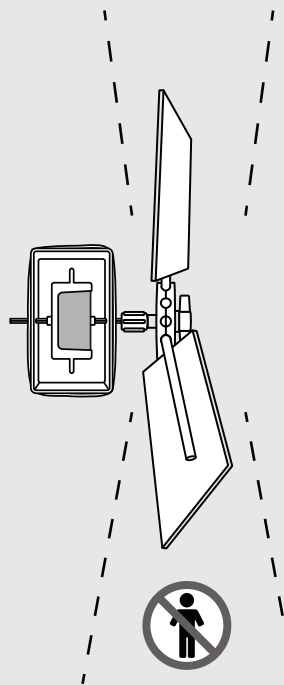

Plane of rotation:
do not stand here!

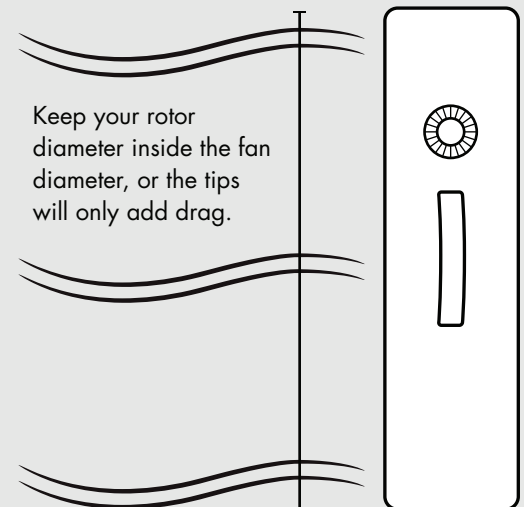

Stand behind or in front of the plane of rotation but not in the plane of rotation (see diagram); and wear safety glasses!

DATA COLLECTION SHEET

Build your generator using the construction plans and materials provided. Be sure to record the variables you changed as you made different generators. How many generators did you wind?

		Data Collected			
		LED INTENSITY (OFF, LOW, MEDIUM, HIGH) AND/OR AC VOLTAGE	Hand Spinning	Drill Spinning	Wind Spinning
Wire Size	Number of Magnets	Number of Turns	Other Variables		
1	Experiment				
2	Experiment				
3	Experiment				

GRAPH

LED INTENSITY AND/OR AC VOLTAGE

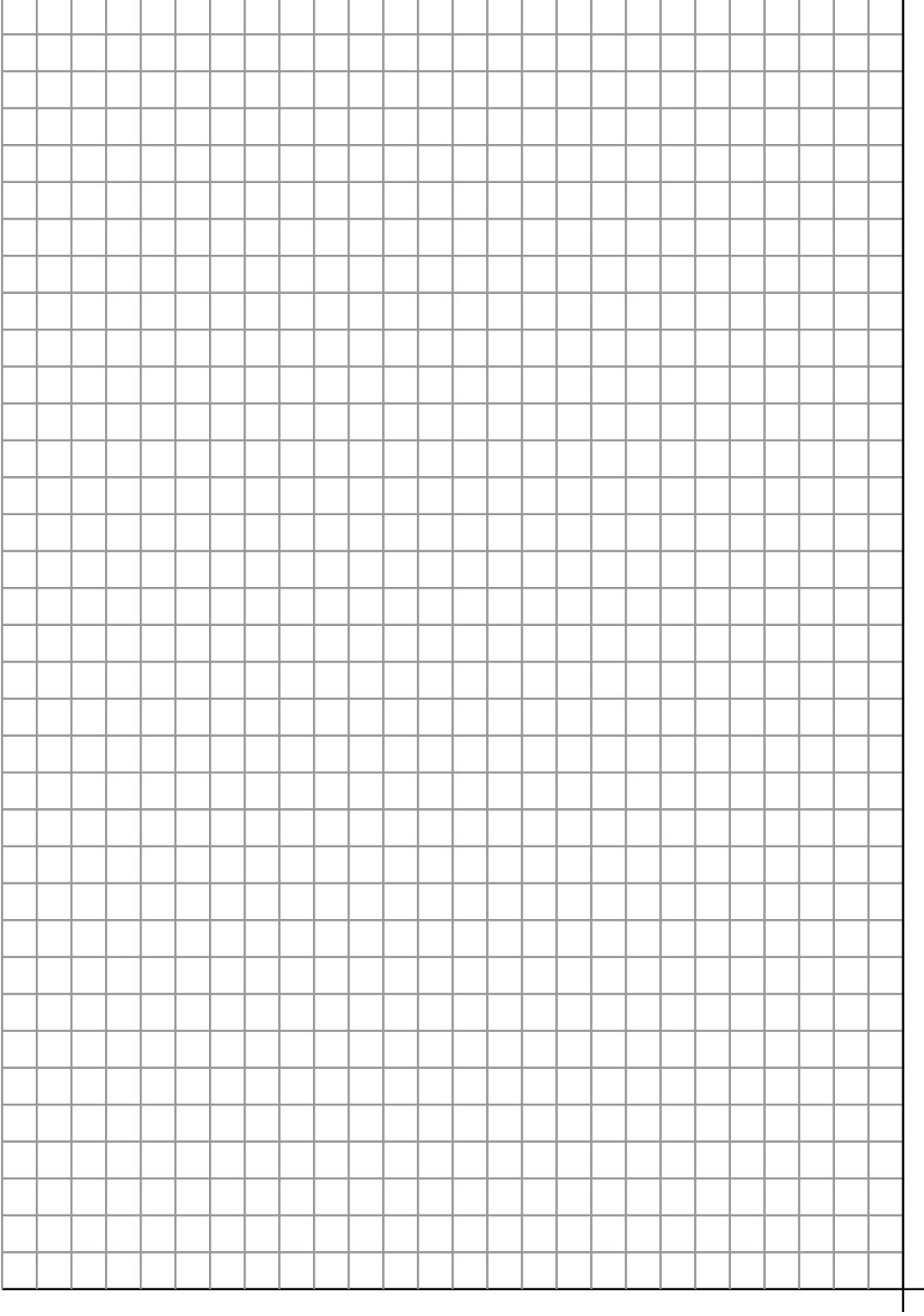

Variables you could test: wire size, number of magnets, number of turns, hand spinning, drill spinning, wind spinning. Can you think of others?

Glossary

Alternating Current (AC)

AC current is electric current that flows in two directions, back and forth, over and over again. The polarity (+/-) at the generator is constantly reversed by alternating the magnetic poles past the coils. Most household outlets have AC current.

Amperage

Amperage is a measure of the rate of flow of electrical charges.

Coil

A coil is a winding of magnet wire. All generators and motors contain coils that vary in size, number, shape, and orientation (i.e. horizontal or vertical).

Current

Current is the flow of electrical charge in a circuit. We can think of current as the amount of water flowing in a tube. The higher the current, the more water is moving in the tube. Low current would be similar to less water flowing in the same size tube. Current is measured in Amperes (A).

Direct Current (DC)

Direct Current is current that flows in one direction. A battery, capacitor, or spinning DC motor all provide DC current.

Electrical Generator

An electrical generator is a device that converts mechanical energy to electrical energy.

Electromagnet

An electromagnet is a magnet that is created using an iron or steel core wound with a coil of wire, through which a current is passed.

Electromagnetic Induction

When a conductor (wire) is placed in a changing magnetic field it causes the production of a voltage across the conductor. This process of electromagnetic induction, in turn, causes an electrical current to flow in the conductor. The amount of voltage and current induced is affected by amount of conductor, how fast the field changes and other factors.

Magnetic Field (flux)

A magnetic field is the space around a magnet where its force is exerted. This force is stronger the closer you get to the magnet and can be stronger or weaker depending on the type of magnet. Different areas of the magnet have opposite or opposing forces. We typically label these areas the north and south poles.

Voltage

Voltage is the electrical pressure or potential difference that drives the electric current.

Wire Gauge

The diameter of the wire can affect how many turns of wire you can get close to the magnetic field.

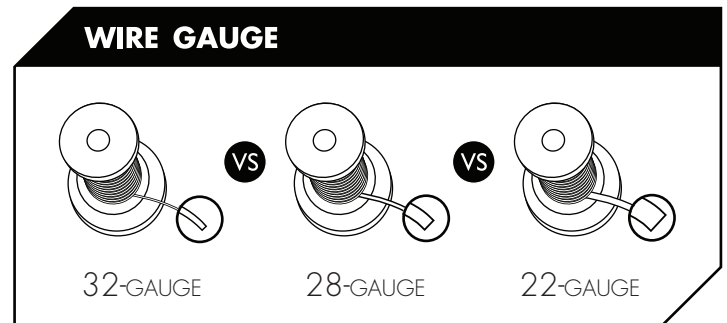

Motors & Generators: Open Some Up

The simpleGen is very, well, simple! It does not have any slip rings, brushes, or complicated orientation of coils and magnets. Because it is simple, it is not the most efficient generator; however, it will help you understand the basics.

To help you understand how real generators and motors work, look around your house, junk yard, or an appliance shop where you can find lots of commercially made generators or DC motors. Dissect some of these so you can compare the “guts” of them to the simpleGEN. What parts are similar? What parts are different?



Inside DC motors.

Further Exploration

If you are working on a science fair project, here are some questions you may want to be able to answer:

1. Where do you think the magnetic fields are affecting the wires the most?
2. How does your generator compare to the inner workings of the commercial generators that you were able to see? How were they different or similar?
3. What parts of the generator had a great deal of friction? How could you improve the design and performance?
4. What generator made the most voltage?
5. What was the minimum number of wire turns needed to light an LED bulb?
6. How might smaller diameter wire affect the windings and the output?
7. If stronger magnets were used, how would that affect the output of the generator?
8. How did the rate of spin affect the output?
9. When you attached the LED bulb, was the generator harder to spin?
10. If you got the bulb to light, did it flicker? Why?
11. What were some of the problems you encountered in building the device?
12. How could you have improved the design of this generator?
13. Where do you find generators?
14. What is the difference between a motor and a generator?

Additional Resources

<http://kwind.me/o8g>

Lots of great information about magnetism, electricity and other subjects from the generator designer, Bill Beatty.

<http://www.magnet.fsu.edu/education/tutorials/java/index.html>

Some of the best applets we have seen on magnets and generators.

<http://kwind.me/u8v>

MAG LAB U. Java applet on how electromagnetic induction works.

<http://kwind.me/u5c>

MAG LAB U. Java applet on how a DC motor works.

<http://kwind.me/x3r>

KidWind Project. Multimeter Tutorials: KidWind has a number of video tutorials on using a multimeter.

<http://kwind.me/t6v>

Otherpower.com. See plans for building a small, home-built wind generator. The links for the stator and magnet rotors are interesting and applicable.

<http://www.animations.physics.unsw.edu.au/jw/electricmotors.html#generators>

University of New South Wales has some great animations of electric motors.

http://www.youtube.com/watch?v=d_aTC0iKO68

Animation of a simple DC Generator/Motor.

<http://www.amasci.com/amateur/coilgen.html>

The original Ultra-Simple Electrical Generator by William Beatty.



800 Transfer Road, St. Paul, MN 55114
www.KidWind.org ♦ Phone: 877.917.0079
Fax: 208.485.9419

© Copyright 2013 All rights reserved