

Materials for 5 Solar Houses or 5–20 Students

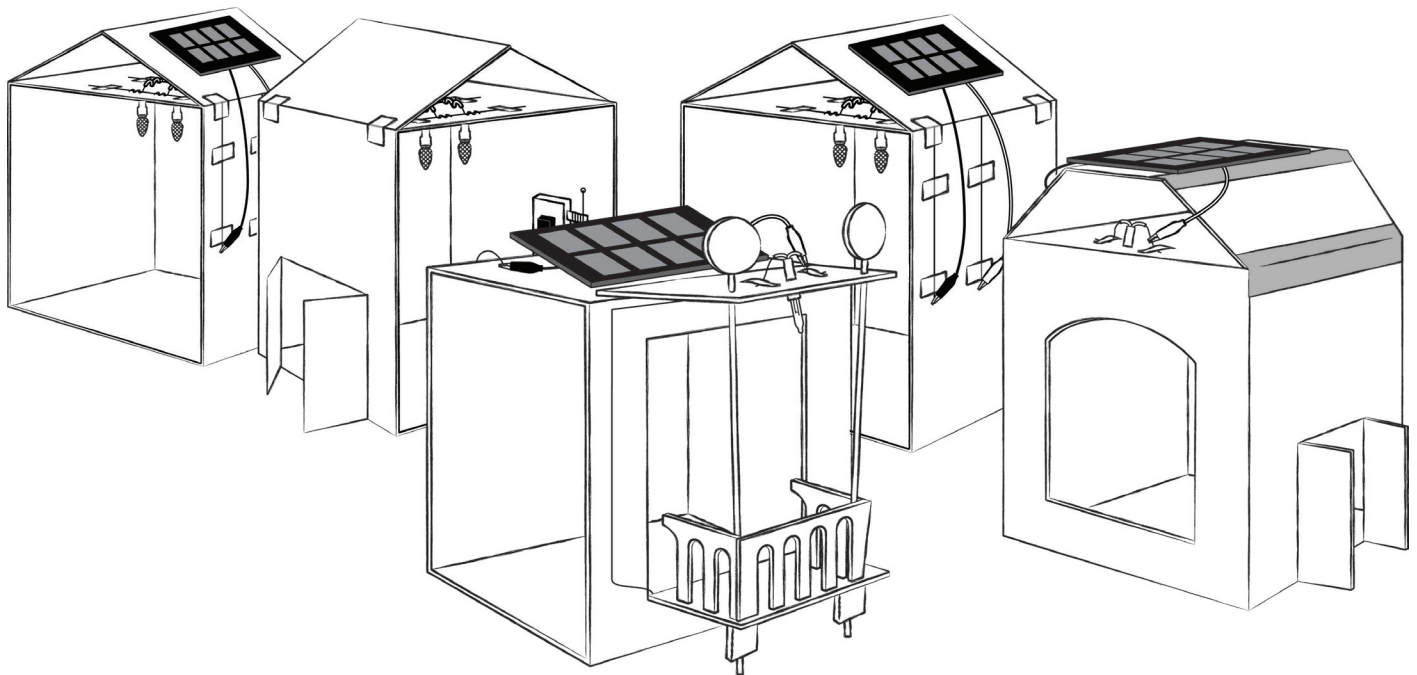

Grades

- 4–12

Time required

- Four or five class periods

Concepts

- Inquiry and science process
- Energy and energy transfer
- Earth science
- Human impacts of natural resource use
- Engineering, art, and design
- Using basic tools
- Collecting and interpreting data

Objectives

At the end of the lesson, students will:

- Understand and be comfortable with basic electrical concepts and terminology
- Understand and be able to build basic circuits
- Know the fundamental aspects of a solar panel and understand how placement and orientation affect its efficiency
- Be familiar with how solar panels are installed on structures
- Be able to use electrical engineering, art, and design skills to build a functioning solar powered electrical circuit
- Be able to use the scientific method to isolate and adjust variables in a solar powered house
- Build teamwork skills during design, construction, and troubleshooting processes (extension activities)

Your REcharge Labs Classroom Kit

The materials enclosed in this kit will help you bring engaging lessons about renewable energy into your classroom. Consider attending a REcharge Training, if you haven't already done so, to enhance your experience using these materials.

About REcharge Labs

We believe that responsible and informed students of today will become our innovative renewable energy leaders of tomorrow. At REcharge Labs, our mission is to provide the resources to encourage this generation of informed thinkers, involved doers, and curious life-long learners.

REcharge Labs provide everything you need to teach renewable energy.

- **Professional development workshops** that prepare you to teach fun, hands-on project-based wind and solar activities.
- **Scalable activities** for different age groups and time frames.
- **Kits and resources** that fit educational standards and your budget.

We recommend attending a REcharge Lab training workshop to enhance your experience using these kits.

REcharge Labs was born out of programming from the KidWind Project, and relies upon KidWind's resources and history to carry out its work. KidWind has been a leader in renewable energy education for over a decade. REcharge Labs, like KidWind, continues to be committed to bringing affordable, hands-on applications of our materials to teachers and students worldwide.

A note on reproduction

Reproduction of this activity guide and associated kit is prohibited except for student use in the classroom. For permission to copy portions or all of this material for other purposes, please contact REcharge Labs at info@rechargelabs.org.



Find kits and sign up for training workshops at
www.rechargelabs.org

Materials

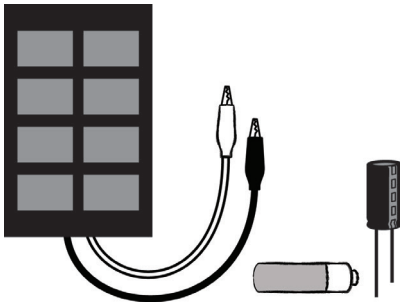

Power Source

Solar panels
AA batteries
Supercapacitor

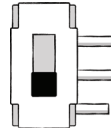

Switch

On/Off switch

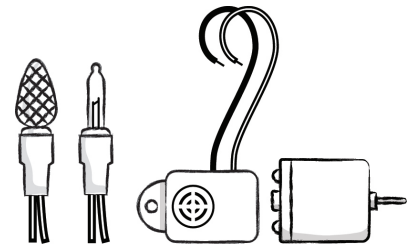

Load

LED bulbs
Incandescent bulbs
Buzzer
Motor

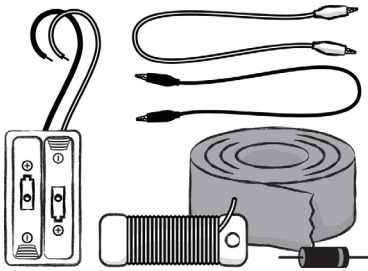

Conductor

Battery pack
Uncoated wire
Clamp wires
Aluminum tape
Diode

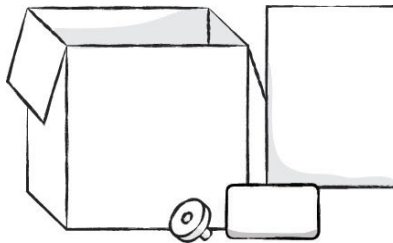

Insulator

Box
Index cards
Motor wheel
Foam sheets

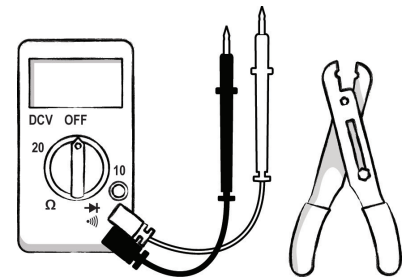

Tools

Multimeter
Wire stripper

You will need to supply the following materials:

- Scissors
- Clear scotch tape
- Protractors
- Rulers
- 1 to 3 Lamp(s)
- High wattage incandescent bulb (100 watts or higher)
- Compact fluorescent bulb (optional)
- LED bulb (optional)
- Hot glue guns
- Colorful markers
- Alternative building material such as craft moss, colorful paper, paint, cardboard (cereal boxes, small boxes), anything that students can use to decorate their houses!
- Your Solar House example (optional)

Background

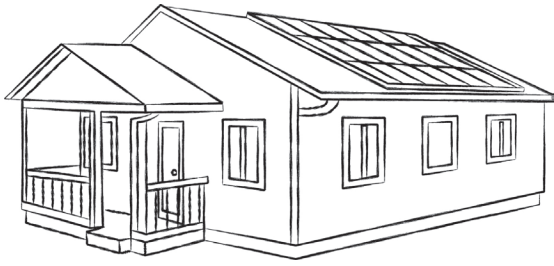

For thousands of years, people have designed structures to capture energy from the sun. Architects in Ancient Rome built openings into the ceilings of domed buildings, like the Pantheon, to fill the interior with as much sunlight as possible. The Pueblo structures in the southwest United States are built of stone and thick adobe (sun-dried mud) walls to keep inside temperatures cool during the day but retain heat at night. Today, we have photovoltaic technology, often in solar panels, to draw energy from the sun and convert it into electrical energy. During this lesson, students will learn how to design and customize electrical circuits to use the power from solar panels, and install it into their own small Solar Town.

Learning Goals

This activity introduces students to basic circuitry and to how energy flows through a system. Students will work individually to build their own Solar Houses, then join together to connect them into a Solar Town. Students will also engage in the Solar Scavenger Hunt to understand how solar panels work and how to make them operate most efficiently. Students will apply this knowledge and use basic electrical engineering skills to design and build an electrical system that is powered by their solar panel.

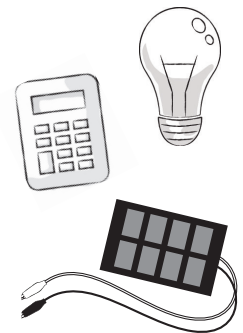

Getting Ready

- Build and test your own Solar House before the class begins. This is a valuable preview to the challenges and problems that students will face. Your example will also help students conceptualize the final product of the lesson.
- Brush up on your circuitry knowledge, as students will have questions. Circuit Tips are highlighted throughout the guidebook to help you troubleshoot.
- Divide materials into individual boxes to distribute to each group. Gather the tools and any additional items students will need to complete the activity.
- Parts of this activity (Class Periods 3, 4, 5) are best done outside on a sunny day, although they can be done indoors using other light sources. If possible, plan to do these class periods during days predicted to be sunny. Cold weather does not harm the electronics or the solar panels.
- For Class Period 3, gather some images of unusual “smart” buildings or structures—like tree houses, houseboats, office buildings, art museums, or satellites—with architectural features that use the power of the sun for lighting, passive solar heating, or collecting energy using solar panels. This will be helpful in starting a conversation with students about why solar power may be needed in some off-grid applications.

Activity

This is a step-by-step activity guide that will take several class periods to complete.

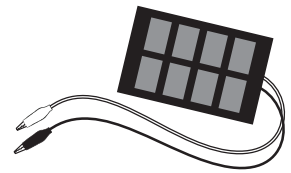

Class Period 1:

Understanding basic circuitry components and exploring conductors and insulators.

Class Period 2:

Understanding polarity, voltage, amperage, and building circuits in series and parallel.

Class Period 3:

Building switches into circuits and introduction to solar power.

Class Periods 4 & 5:

Planning, building, installing, and testing the Solar House.



CLASS PERIOD 1

Understanding basic circuitry components and exploring conductors and insulators.

Step 1: Beginning questions for students

- What is a power source?
- What is an LED?
- Name some things that are conductive, meaning that electricity can flow through them.
- Name some things that are insulators, meaning that electricity cannot flow through them.

Step 2: Distribute materials

Prepare the materials for the activity by sorting the items listed below into the Solar House boxes. Each box will contain:

- AA battery pack
- 2 AA batteries
- 2 feet of uncoated wire
- 2 white LEDs
- 2 colorful LEDs
- 2 colorful incandescent lights
- 2 index cards
- 1 foot of aluminum tape
- 1 solar panel
- 1 motor
- 1 motor wheel
- 1 switch
- 1 pair of clamp wires

Have the following tools ready, but don't distribute

them until they're required: scissors, clear tape, wire stripper, and multimeter. Organize the students into groups of one to five. Give each group one box of materials. They can look at the materials, but can't touch yet!

Step 3: Identify the circuit components in the box

Before students build their Solar Houses, they have to understand what a basic circuit is, the key components of a circuit, and how to create and customize a circuit.

Write five circuit vocabulary terms on the board: **power source, switch, load, conductor, and insulator.**

Give students time to dig through their boxes and discuss within their groups what the items inside are. Have each group choose a member to go up to the board and write down what the group thinks each item in the box is called, and place it under the category they think it belongs to. They may not have any idea yet, that's okay!

When all groups have gone to the board, talk about the results on the board, and clarify any items that seem to cause confusion. Some items will be placed in multiple categories. The results should look like this:

Power source: *batteries, solar panel, supercapacitor*

These items are the source of power for a circuit. You must have a power source to have a working circuit.

Switch: *on/off switch*

A switch is something that controls the circuit. For example, a switch turns a circuit on or off, like a light switch in a house.

Load: LEDs, incandescent lights, motor

A load is the work the power source has to do. For example, an LED lights up or a motor spins when connected to a battery. You may need to identify the difference between the LED and incandescent light.

Conductor: uncoated wire, aluminum tape, clamp wires, battery pack, motor, solar panel, LEDs, incandescent lights, batteries, diode, supercapacitor

A conductor allows for electricity to flow easily. Metal wire is conductive because it is made of steel, copper, or aluminum. LEDs and motors have conductive parts in them. Some things are **semi-conductors**, like water, or people. Electricity flows through semi-conductors, but not easily.

Insulator: Solar House box, motor wheel, the rubber on the clamp wires, the wax paper on the back of the aluminum tape, the rubber on the wire of the LEDs and incandescent lights

Insulators are items through which electricity cannot flow. For instance, the clamp wires in the kit have conductive wire wrapped in a rubber insulator coating.

Step 4: Explore conductivity using a multimeter

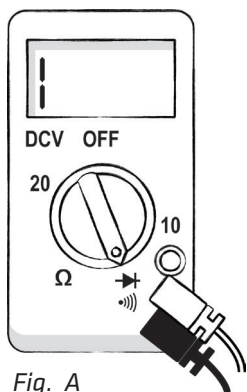

Fig. A

Conductor Scavenger Hunt

Hand each group a multimeter, and tell students to dial their multimeter to what looks like a radio symbol, and make sure the probe wires are plugged in correctly (Fig. A). Tell the groups to touch the red probe to the black probe to see what happens. There should be a noise, indicating that the surface they are touching is

conductive. If there is no noise, make sure they are on the proper setting. Now have the students touch the items in their kit with both the red and black probes to see if they are conductive. Students can also test surfaces within the classroom.

Safety warning!

To avoid electrocution, do not touch anything with the multimeter that is attached to wall power, or any outlets. Additionally, multimeter probes can be pointy! Be careful not to poke or scratch with them.

Chain of Conductive Found Objects

Ask students to create a chain of conductive materials with some of the items they have found to be conductive. They should make sure the conductive parts of the materials are touching each other (i.e.: a binder ring, but not the plastic cover of the binder). Using a multimeter, test to see if the chain of materials allows electricity to flow through them. Place the red probe on one end of the chain and the black probe on the other end. Does the multimeter make a noise?

Step 5: Clean up

Have students write their name inside their box, and place all the circuit components back inside to store until next class period. Students should make sure the multimeter is off, take the batteries out of the battery packs, and hand in the tools and the multimeter.



CLASS PERIOD 2

Understanding polarity, voltage, amperage, and building circuits in series and parallel.

When beginning to explore the world of electricity, start with its three basic building blocks: voltage, current, and resistance. Since we cannot see energy flowing through a wire or the voltage of a battery, we must use measurement tools like multimeters to visualize what is happening with the charge in a system. We also use loads, like lights and motors, to see and feel how the circuit is working.

Step 1: Beginning questions for students

- What kinds of batteries are there? (for example: AA, AAA, 9-volt)
- What makes batteries different from one another?
- What is a short circuit? What happens when something short circuits?
- What kinds of lights are in a building? What are the differences among these lights?

Step 2: Prepare materials

Pull out the battery pack, two AA batteries, two LEDs, two incandescents, and the uncoated wire. Each group will need wire strippers, scissors, a multimeter, and tape. The students will need to cut the wire into two 8-inch pieces with a scissors. Each group should also get one piece of 8.5"x11" paper.

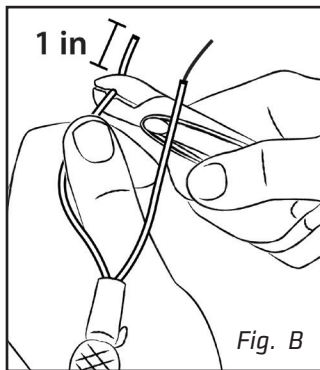

Step 3: Practice stripping wire

Using the following steps, have students use a wire stripper to strip 1 inch of the rubber coating off the wires of the LEDs, incandescents, and the battery pack. Practice first on the lights, and do the battery pack last.

They must make sure the battery pack is empty when stripping wires (Fig. B). Squeeze the wire stripper gently around the rubber coated wire, scoring the rubber all around. Pull the rubber off the wire, and it should easily slide off. If not, cut deeper. Don't cut too deep or the tool will just cut through the wire! The exposed wire is often threaded, meaning it has many strands of copper wire in it. If the small copper wires get frayed while stripping, just twist the frayed wires together.

Step 4: Battery as a power source

Ask the students to read the label on a single battery. From the label, they can gather some important information about this power source, and learn some new vocabulary words. Write **polarity**, **voltage**, and **amperage** on a board, then ask the students what they think those things are, based on the battery label in their hand.

Polarity. Ask students to find the positive and negative side of the battery. Polarity is symbolized as a (+) or (-) sign, and those symbols are printed on the battery (Fig. C). Batteries are a direct current (DC) circuit, meaning, one pole is always negative, the other pole is always positive, and the electrons only flow in the direction of negative to positive.

Voltage. Ask students to find the voltage listed on the battery. V is the symbol for voltage. Voltage is the amount of potential energy between two points on a circuit. The battery the student have will probably say 1.5V on the label.

Measuring the potential voltage of a battery. Ask students to check to see if the potential voltage listed on the battery is correct with a multimeter, using the following steps. Turn the multimeter to the position shown in the direct current (DC) range (Fig. C). Place the red probe on the side of the battery with the plus sign on it, and the black probe on the other side of the battery. Students should see a number on their

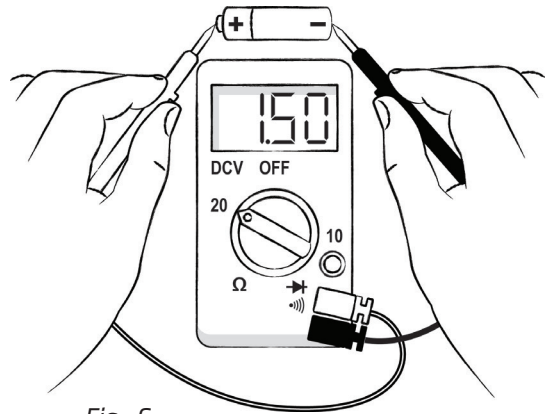

multimeter. Some of the students may get a negative number, that is because their probes are reading the polarity backwards (their red and black probes are switched). It may not read exactly 1.5V. If the battery is old or used, it will have lost some of its charge. If new, most often the battery will be close to 1.75 Volts, which is normal in manufacturing.

Amperage (amps for short). Amps measure electrical current. A is the symbol for amps. Amps are important because they are the easiest way to distinguish the strength or capacity of a battery. Amps will not be listed on a regular alkaline battery.

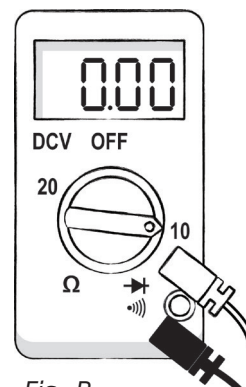

Measuring the short circuit amperage of a battery. Ask students to use a multimeter to see the highest amperage reading the battery can give. Students should set the multimeter to the position shown in the diagram; notice the positive probe is plugged into a different hole on the multimeter (Fig. D). This position will allow us to read short circuit amps. In the 10 A setting, the multimeter should be reading somewhere around 2.00–8.00 Amps or 2000–8000 milliamps for a single AA battery.

What is the difference between voltage and amperage? Amperage is a measure of the amount of electricity used. Voltage measures the pressure, or force, of electricity. Think of it this way: electricity flowing through a wire is like water flowing through a garden hose. The amount of water that can fit through the hose depends on the diameter of the hose (amps). The pressure of the water depends on how far open the faucet is (volts). Volts and amps will make more sense during the next activity.

Step 5: Place the batteries in the battery pack

Students have been using a multimeter to read the voltage and amperage of one battery, but the battery pack contains two AA batteries. What will happen to the voltage and amperage readings of a battery pack with two batteries? Ask students to use the multimeter to find out (Fig. E). The voltage should have doubled, to around 3 volts. The amperage will be about the same.

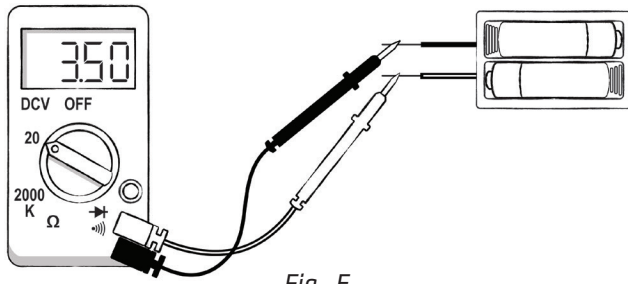

Fig. E

Step 6: Watch out for short circuits

A short circuit is an important safety issue to bring up with students. It is easy to prevent, but a short circuit will probably happen at least once during the activity. A short circuit occurs when two conductive parts are touching within a circuit, causing a path of very low resistance and easy conductivity (Fig. F).

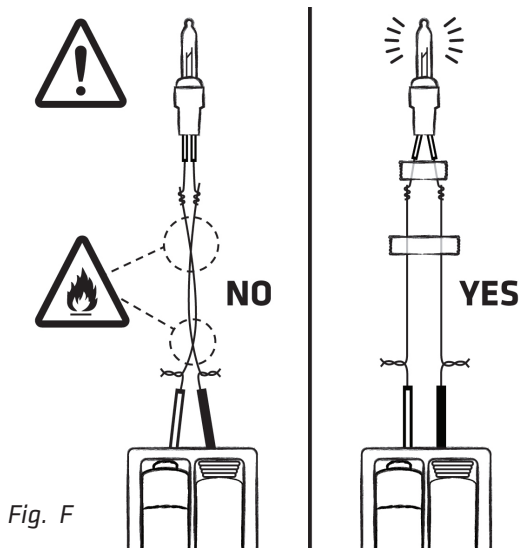

Fig. F

A sure sign that a circuit is shorting is that the circuit is not working, and the battery pack is hot. To avoid short circuits, students need to remove the batteries from the pack while they are building (Fig. G). The batteries should be placed back in the pack only when all the connections are correct, and there are no wires

crossing. Students have to be careful of their circuit the entire time they are working on it, and when they are not working on it. In between class times, or when moving the circuit, they must remove the batteries.



Fig. G

CIRCUIT TIP #1: HANDLING A SHORT CIRCUIT

If there is a short circuit: first, pull apart the wires that are causing the short circuit, and make sure there are no other stray conductive parts touching each other. Then, remove batteries

from the battery pack with a pencil (not something conductive!). Do not touch batteries, because they will be hot. The batteries will cool down in a couple minutes and be fine to use again.

Step 7: Light an incandescent bulb

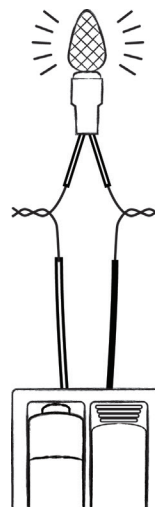

Fig. H

An incandescent bulb has two wire legs, which students have already stripped to expose one inch of wire. Have the students place one wire on a battery pack wire, and another leg on the other battery pack wire (Fig. H). The bulb should light up. If it doesn't, make sure the exposed parts of the wires are touching. Students may need to press down on the wires

to make a good connection.

Step 8: Light two incandescent bulbs in a series circuit

Students should separate the battery pack from the bulb. This time the students will connect one leg of the incandescent bulb to the leg of another incandescent bulb (Fig. I). The two outer legs will connect to the battery pack. This type of connection is called a series circuit. Think of it as people

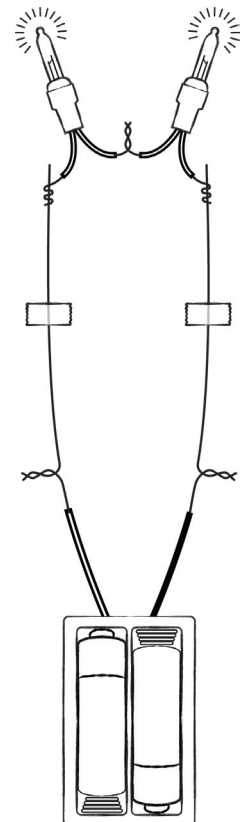

Fig. I: Series circuit

holding hands in a series or a line. Students can add more bulbs, continuing to attach each additional bulb in series. The more bulbs they attach in series, the harder the batteries have to work to turn them on, so they may notice that the bulbs are getting dimmer.

Step 9: Light an LED

Next, have students try to light a LED on their own using the same instructions. They should use the same battery pack, just removing the linked incandescent bulbs and putting them aside for now. Does it work? Some students will get theirs to light, and some won't. LEDs are polarity sensitive, meaning that even though the wires from the LEDs aren't color coded, one leg is positive, and one is negative. Students won't know which is which until they hook a battery pack to it. If theirs didn't work one way on the battery pack, try switching the wires (Fig. J).

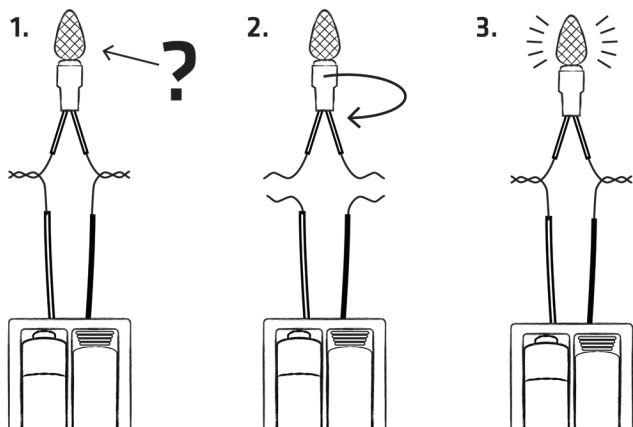

Fig. J

CIRCUIT TIP #2: **LEDS ARE POLARITY SENSITIVE**

As students continue to add to their circuits, it helps to know that an incorrectly wired LED will cause a circuit to not work. LED stands for Light Emitting Diode. Light emitting makes sense, because it's a light, but what is a diode? A diode is like a valve. The power can only go one way, through the positive leg of the LED to the negative leg of the LED.

Step 10: Light two LEDs in series

Have students try hooking up the LEDs in series to get them to light. This will not work! Even if students try to light one LED and one incandescent, it still will not work. This is because more power is needed, like a 9-volt battery. If your students are really ahead, they can hook two battery packs in series to get 6 volts, and then try to get two LEDs to light in series.

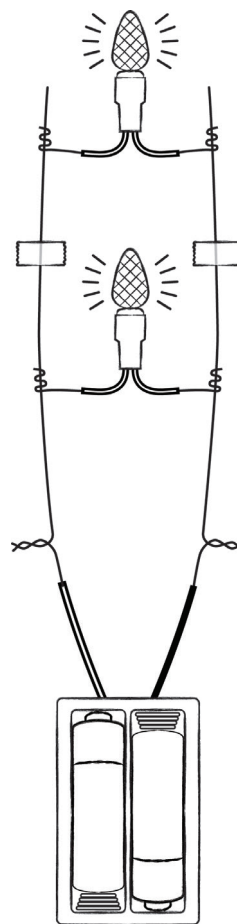

Fig. K

Step 11: Light two LEDs in parallel

Another type of circuit, called a parallel circuit, allows for more flexibility when building complex circuits. A parallel circuit is like a railroad track, where the loads are the railroad ties on the tracks. The two 8-inch pieces of uncoated wire will be the tracks. One track is positive, and is attached to the positive battery wire. The other track is negative, and is attached to the negative battery wire. The wires can get unwieldy, so have students tape the track to the piece of paper, along with the battery pack. That will ensure that the wires will not cross and short circuit. Now, place both legs of one LED on the track, like the railroad ties. It should light up! If not, turn it around, as in step 9. Place another LED on the track in the same way. See Fig. K for help. When both LEDs work, twist the wires into place.

CIRCUIT TIP #3: **MAKE GOOD CONNECTIONS**

Students need to make sure the wires are twisted really well, and that there are no loose connections, or the lights will not light up. Loose connections are usually the culprit when a circuit is not working.

Step 12: Clean up

Ask students to remove the batteries from the packs and store the batteries in the box. Have students write their name on the piece of paper, with the circuit still taped on it, and store that in their box to use for next class period. Make sure the multimeters are off, and have students hand in the tools.

Step 13: Reading for homework

In the next class, students will begin using solar panels. Understanding how a solar panel produces electricity is important in knowing why it works! Have students do the brief reading on page 18, or find additional resources that will help them understand.



CLASS PERIOD 3

Building switches into circuits and introduction to solar power.

Step 1: Beginning questions for students

- How many types of switches can you name? How do they work? (for example, sound, light, on-off, motion sensor)
- What makes a house or a building “smart”?
- What make a house or building “green”?
- Who has seen solar panels before, and where?
- From your homework last night, can you explain how a solar panel works?
- What variables do you think affect how much energy a solar panel produces?

Step 2: Prepare materials

Have students carefully take out their piece of paper with the circuit attached, the two AA batteries, aluminum tape, uncoated wire, and one index card. Keep the batteries out of the packs for now. Each group will again need wire strippers, scissors, multimeter, and tape.

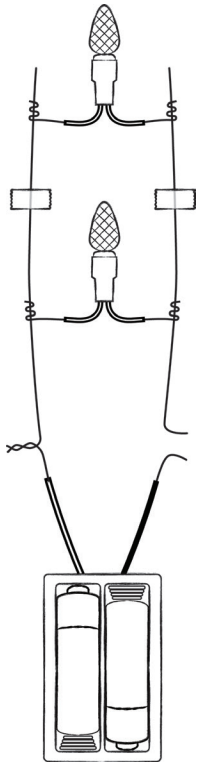

Fig. L

Step 3: Build switches into the circuit

Switches make it easy and safe to control power flow, which is critical in circuitry. Think about what would happen if a television didn't have an on/off button, or if a house didn't have any light switches!

Making sure the batteries are still removed from the packs, have students choose one of the uncoated wires coming off the battery pack (in between the battery pack and the first light). Using scissors, cut the wire (Fig. L). Now they may put the batteries in. The circuit will not light up because the flow of electricity has been cut from the power source. Students will build a switch in this break to make the circuit work again!

Manual switch. The simplest switch is a manual switch, which students can simply control with their hands. Tell students to touch the two cut pieces together. The circuit lights up! When

the cut pieces don't touch, the lights are off. This is the basic structure of most switches, like the light switch in a house.

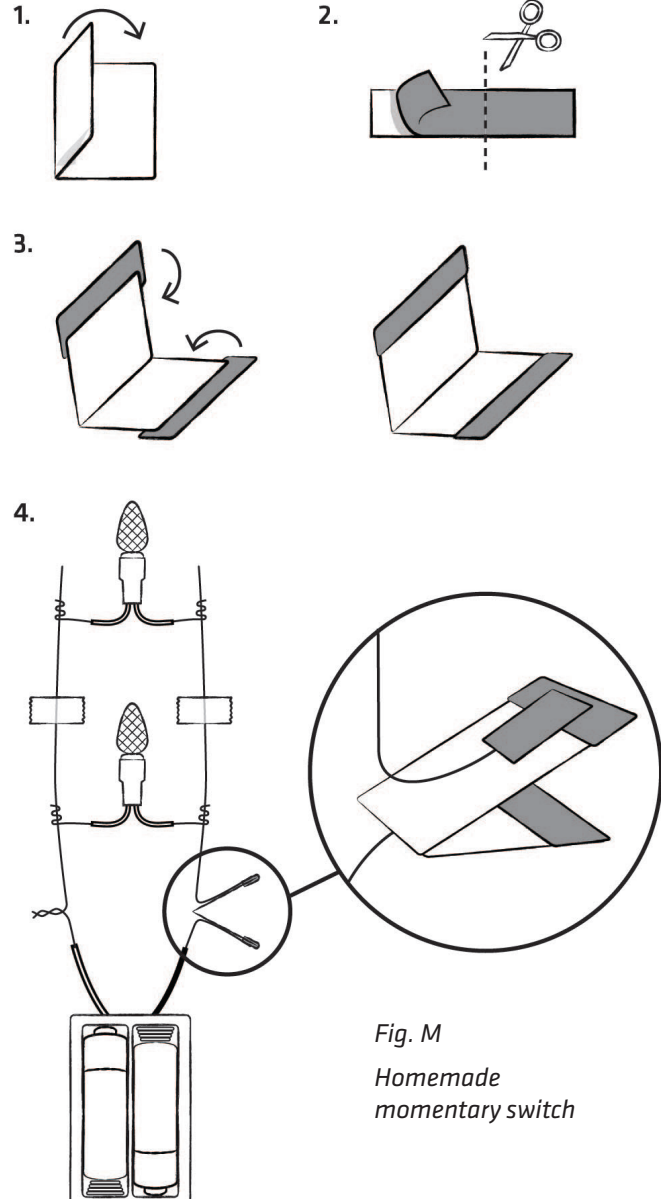

Fig. M
Homemade momentary switch

Momentary switch. A momentary switch turns on when pressed, but turns off as soon as it is released. A doorbell is a good example of a momentary switch.

Have students make their own momentary switches, using the following instruction. First, fold the index card in half so it acts like a jaw (Fig. M-1). When the jaw is squeezed and released, it opens and closes. Then, make the lips on the jaws conductive: cut two pieces of aluminum tape into 1-inch lengths, remove the wax paper from the back of the aluminum tape (Fig. M-2), and stick the pieces of tape around each lip of the jaw (Fig. M-3). Next, cut two 4-inch pieces of

uncoated wire. Place one of the wires on the top part of one lip, over the aluminum tape. Tape the wire down using a small piece of aluminum tape. Do the same to the other side. This is a momentary switch! Twist one of the wires coming off the jaws to one of the cut wires in the circuit. Do the same to the remaining pair of wires (Fig. M-4). Test to see if the switch works!

When students are building their Solar Houses, this switch works great in a feature like a doormat that turns on a light if a “person” walks over it! Students can also experiment with adding this switch in other places around their circuit, controlling different loads at different times (Fig. N).

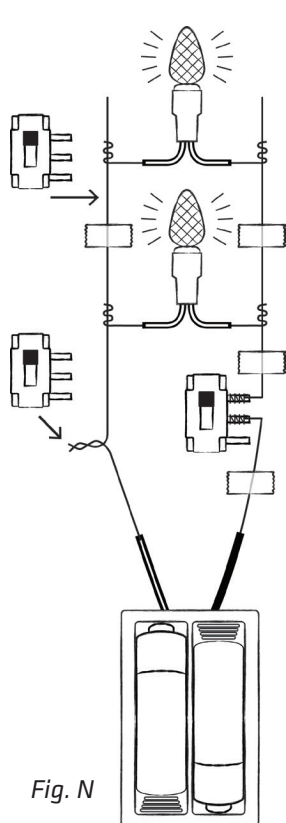

Fig. N

On-off switch. An on-off switch is like a light switch. This switch turns components on and keeps them on until they’re shut off. Students can use the pre-made ones in their boxes, and connect using the following instructions. Untwist the momentary switch from the circuit and save it for later. Cut two 4-inch pieces of uncoated wire. Notice that the provided on-off switch has three short metal pieces protruding off it. Twist one wire around the middle metal piece, and twist the other wire around a side piece (doesn’t matter which side). Attach the extended switch wires to the circuit

(Fig. O). Now slide the switch up or down to see what turns the circuit on or off.

**CIRCUIT TIP #4:
INSULATE WIRES SO THEY
DON’T CROSS**

When making complex switches, it is likely that uncoated wires in the circuit will cross. To prevent this, have students insulate the uncoated wire with scotch tape in troublesome areas to make sure the wires don’t touch accidentally.

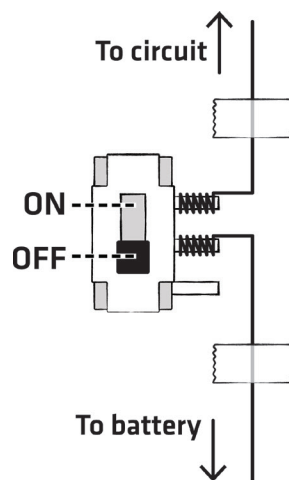

Fig. O

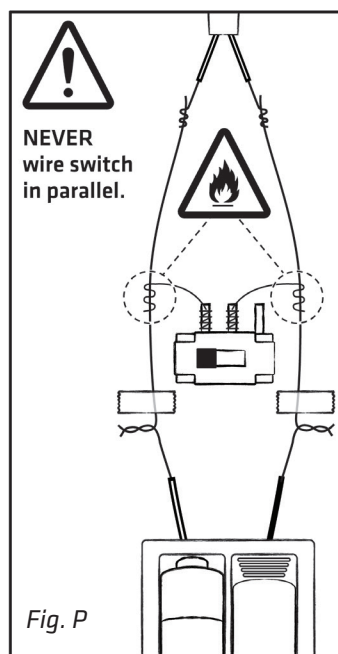

Fig. P

**CIRCUIT TIP #5:
CONNECT SWITCHES
IN SERIES**

A switch can be added to a parallel or series circuit, but the switch can only be wired in series with the circuit (Fig. N). If students wire a switch in parallel, they are wiring a short circuit that shorts every time they turn it on! This will also cause the circuit to not work (Fig. P).

Have students set their circuits down for

now. Make sure the switch is in the off position, and ask students to remove the batteries from the circuit. It’s time to shift gears into using the solar panel as the power source.

Step 5: Solar Scavenger Hunt

The Solar Scavenger Hunt introduces students to some of the variables that they must account for when installing a solar panel. Students can now remove the solar panels from their box. Distribute the multimeters, protractors, rulers, and copies of the Solar Scavenger Hunt worksheet on page 19 of this guide. This activity is best done in groups, with one student holding the panel, one the multimeter, one the protractor and ruler, and one collecting data.

First, identify different light sources as a class. Encourage students to think about indoor and outdoor options. What are different types of light bulbs? Also prompt them to think about how different variables affect the light, like different colors, reflective surfaces, shade, through clouds, or through windows. What might different angles and distances from the light source do to the solar panel’s effectiveness?

Use a multimeter to test different light sources with a solar panel. Have students connect their multimeter to the solar panel and turn the multimeter to the position shown in the direct current (DC) range, (Fig. Q). They will collect data using the worksheet. Encourage them to do multiple tests in the same area, changing one variable at a time, like angle or distance.

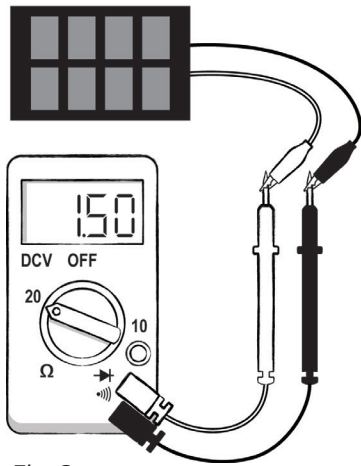

Fig. Q

Afterwards, reconvene as a class to discuss the data gathered. Have students come up to the board and write two of the most powerful and two of the least powerful light sources they tested, including angle and distance, and record the power output from the multimeter. When every group has added

to the list, ask students to reflect on the data and discuss which areas they think are more efficient places to build solar panels, and why.

Step 6: Clean up

Ask students to remove the batteries from the circuits, and put everything in the box, turn off the multimeter, and hand in the tools.

Step 7: Inspiration for homework

In the last part of class, show students the images you gathered of the unusual “smart” buildings or structures. For their homework direct students to think about what their house is going to look like, and what features it will have.

In the next class period, students will create and install electrical features, build a house using the box as a starting point, and hook up their solar panels.



CLASS PERIODS 4 & 5:

Planning, building, installing, and testing.

Step 1: Beginning questions for students

- What kind of house are you building?
- What are its features?
- What will each group member contribute?

Step 2: Prepare materials

Each student needs everything in their boxes. They may also need wire strippers, a multimeter, protractor, ruler, a hot glue gun, and scissors. On a separate “construction” table, lay out the skewers, foam sheets, any additional decorative material, and colorful markers.

Step 3: Make a plan

Give students 10–15 minutes to make a design plan with their group. They should already have some ideas from their homework! Ask them to draw on a piece of paper what the house will look like and what it will do. In particular, tell them to mark where circuit loads, the switches, and the power source will be. Make sure all members in each group have equal say in planning.

Step 4: Build the basic structure

Once they have a design in mind, students will focus on building the basic structure of the house. It doesn't have to remain a one-room structure. It can be transformed into multiple levels or rooms. Cut the extra cardboard flaps off the box (Fig. R) and use them as floors, walls, or part of the roof. Students will be installing a solar panel on the roof once a basic structure has been built. Remind them to refer back to their Solar Scavenger Hunt worksheets when building their roofs.

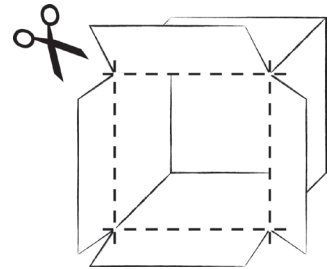

Fig. R

Step 5: Design and install the electrical features

Students are not required to keep their circuits in parallel. Now that they know how to make a circuit in series and parallel, and how to add a switch, they can make a circuit however they'd like. All the materials in their box are available for them to use now, plus anything else you provide or they find. Let them add small boxes, fabric scraps, or other add-ons they bring from home. This is the time they get to build their features. Please refer to the illustrations on how to add a motor in the circuit (Fig. S). The motor wheel goes on the axle of the motor shaft, and makes it easier to attach objects to the motor, like fan blades, or disco balls. For students who are ahead, there are sound buzzers in the kit. The buzzers can be added into the circuits the same way as the lights.

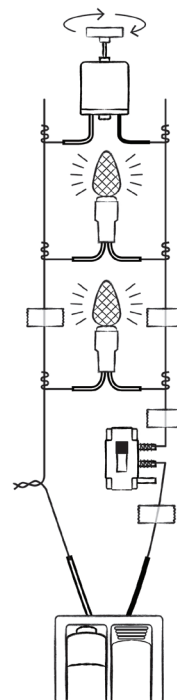
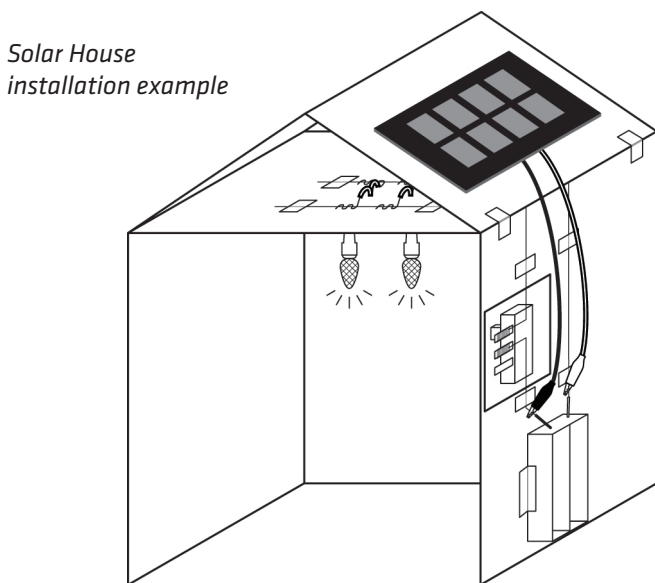
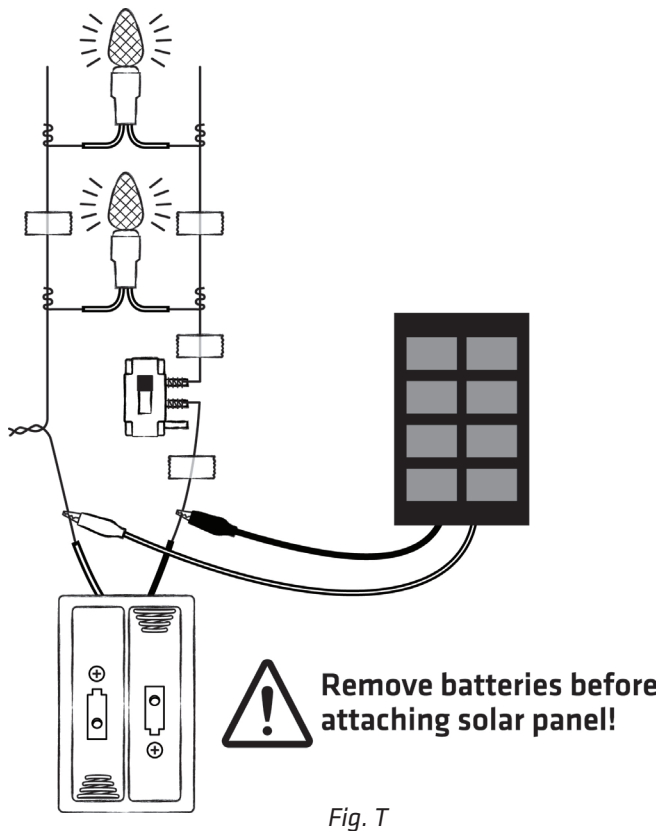

Fig. S

Step 6: Solar installation

Before the solar panels are installed, the installed circuits have to work. Student should test with the batteries first, being cognizant of the polarity. If the circuit works, remove the batteries and attach the solar panels (Fig. T). If they need the solar panel wires to be longer, they can use the clip cords to extend the wires. Students may want to affix the panel to the house; have them wait to do that until they have tested the most efficient placement and angle.



Step 7: Improve designs

Once the solar panels have been installed, all of the features may not work as well as they did with the batteries. Continue to adjust circuit layout and solar panel arrangement until everything works. Have students keep building and testing their houses.

Step 8: Energy storage

How can a solar panel power a house on a cloudy day, or at night? In solar-powered structures, energy storage is built in to solve this problem. There is an option to add an energy storing device to students' houses by adding a supercapacitor (supercap) to the circuit. Supercaps are somewhat like rechargeable batteries. Students should follow these instructions to use one in a Solar House. Unhook the solar panel from the house, and hook one leg of the panel to the diode. (The diode prevents the supercap from heating up the solar panel, since they are two power sources.) Then hook the diode leg to the supercap, paying attention to polarity (Fig. U). Charge the supercap by placing the panel in the sun for a couple of minutes. Use a multimeter to see how much it has charged. Then detach the supercap and diode from the panel, and attach the supercap to the house's wires, paying attention to polarity (Fig. V). The charge in the supercap should power the house for a minute or two.

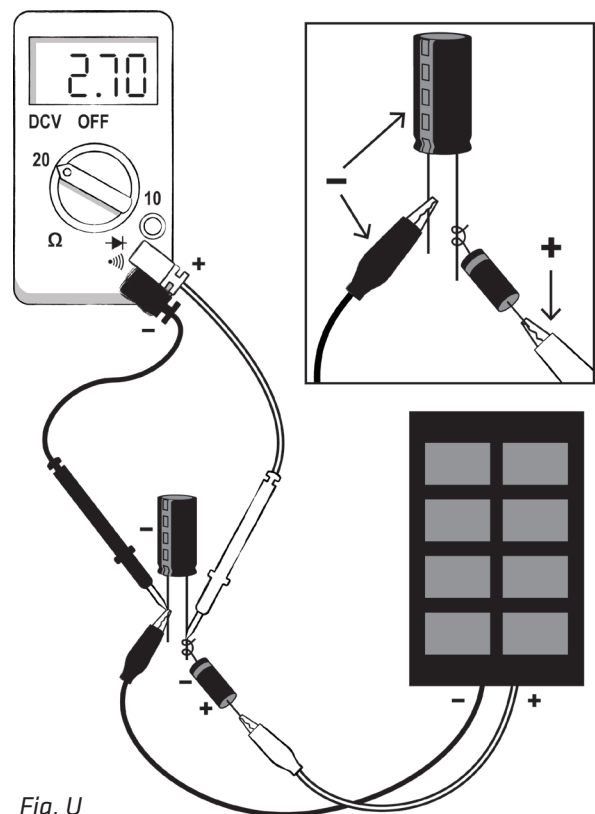

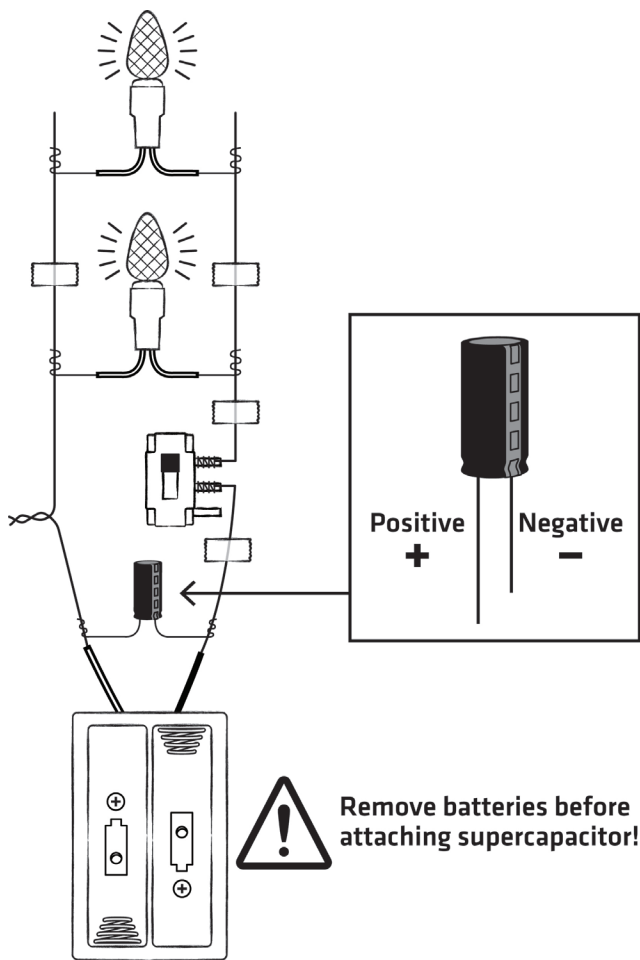

Fig. V

Step 9: Discussion

Have students go around and look at their peers' houses. What do they have in common? What is different? What aspects do they think are cool or creative? These aren't much like real houses, but they do model electricity flow in a very simple way. How did the process of construction make them think about challenges that real solar homes may face?



Solar Town Extension Activities

Solar Panel Array

Students will learn how to connect multiple solar panels, and experiment with what more power can do for their house.

Build the Solar Town

Connecting houses from an entire classroom can be a great way to model a solar powered town's electrical grid, delving deeper into the obstacles of constructing a solar array that can directly power a small town.

ACTIVITY 1: SOLAR PANEL ARRAY

Students will learn how to connect multiple solar panels, and experiment with what more power can do for their house.

Step 1: Prepare materials

Hand out more solar panels if you have extras, or combine groups so that they can share two panels. The materials needed are clip cords and a multimeter, one each per group. Students will use the Solar Houses they already constructed.

Step 2: Connect the panels

To start, have students use the multimeter to read the short circuit amperage and voltage of a single solar panel in the light source of choice. They should take note of the numbers they are getting (Fig. A).

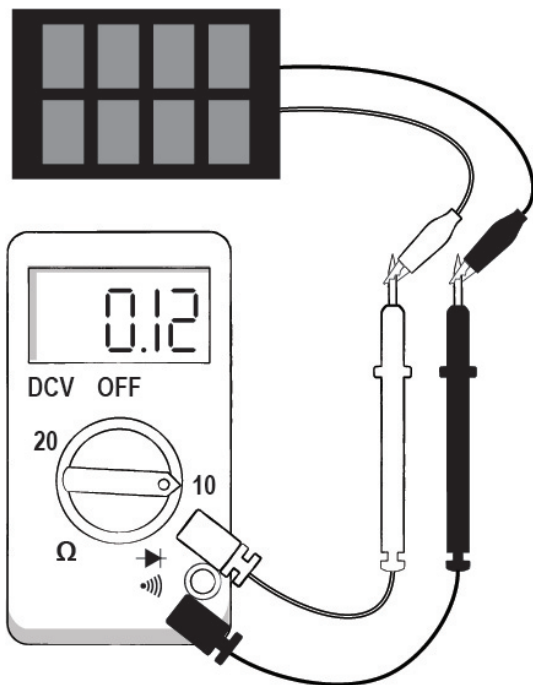

Fig. A

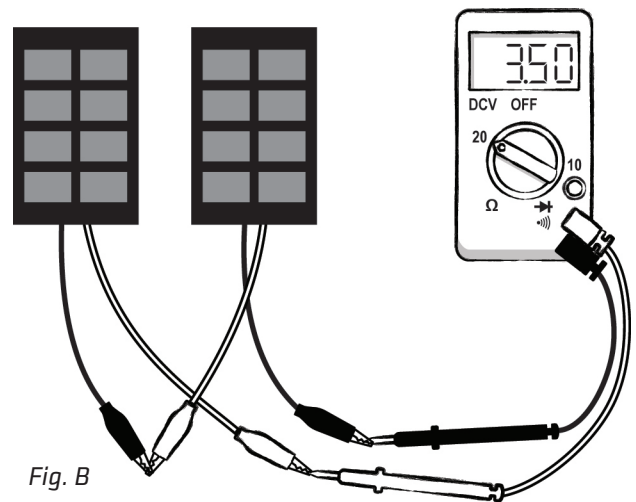

Fig. B

Wired in series

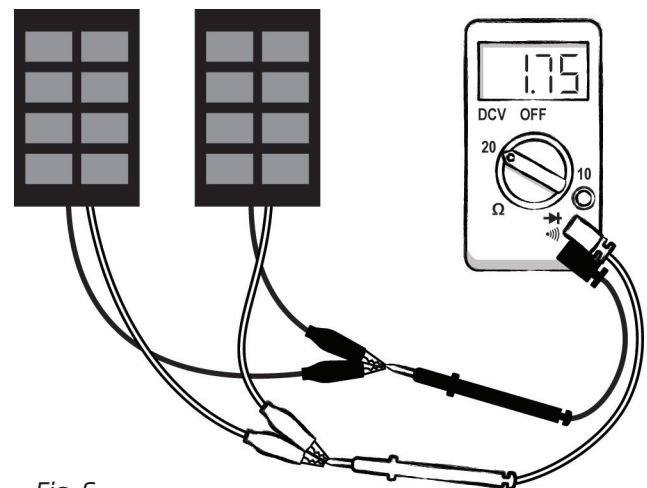

Fig. C

Wired in parallel

Then, they should connect the two panels in series, clipping the red wire to the black wire (Fig. B). Using the multimeter, they should measure both amperage

and voltage, noting what happens to those numbers. How did that change from the numbers they got from the single panel? Now, have them connect the two in parallel, clipping the red to red wire and black to black wire (Fig. C). Using the multimeter, they should again measure amperage and voltage and note the changes.

Students should be getting approximately double the voltage when they hook up two solar panels in series, but still around the same value for amperage. When the two panels are in parallel, the amperage should almost double, while voltage remains around the same.

Step 3: Hook up to the house

Using what they learned about the amperage and voltage differences of panel arrangement, have students should connect their arrangement of choice to their house. Does this have the effect they anticipated? If not, they should switch it to the other panel arrangement and see if that makes a difference.

Given what they have learned, how do students think solar panels on the grid are connected? On a large solar farm, is it more beneficial to increase the voltage or the amount of amperage produced?

ACTIVITY 2: BUILD THE SOLAR TOWN

Connecting houses from an entire classroom can be a great way to model a solar powered town's electrical grid, delving deeper into the obstacles of constructing a solar array that can directly power a small town.

Step 1: Lay out the town

Now that students have built their own individual Solar Houses, and know how to create the most powerful array of panels, they can build an entire town connected to a solar grid!

Have students remove the solar panels from the individual houses, remembering which side was positive (red) and which was negative (black). Students should connect their town in a parallel circuit. Tape two long pieces of uncoated wire to the table about two feet apart; these are the town's transmission lines. The left wire will be positive and the right will be negative. Have students connect the houses to these wires in parallel, using the clip cords, connecting the red cord from a house to the positive transmission wire, and the black cord from the house to the negative transmission wire. Students should complete the chain of houses this way (Fig. D).

Step 2: Connect to the grid

Next, have students build the solar array with all the panels using the circuit they decide is best. Connect the array to the ends of the transmission lines, paying attention to the polarity of each line. If the array is not providing enough power, try a different arrangement.

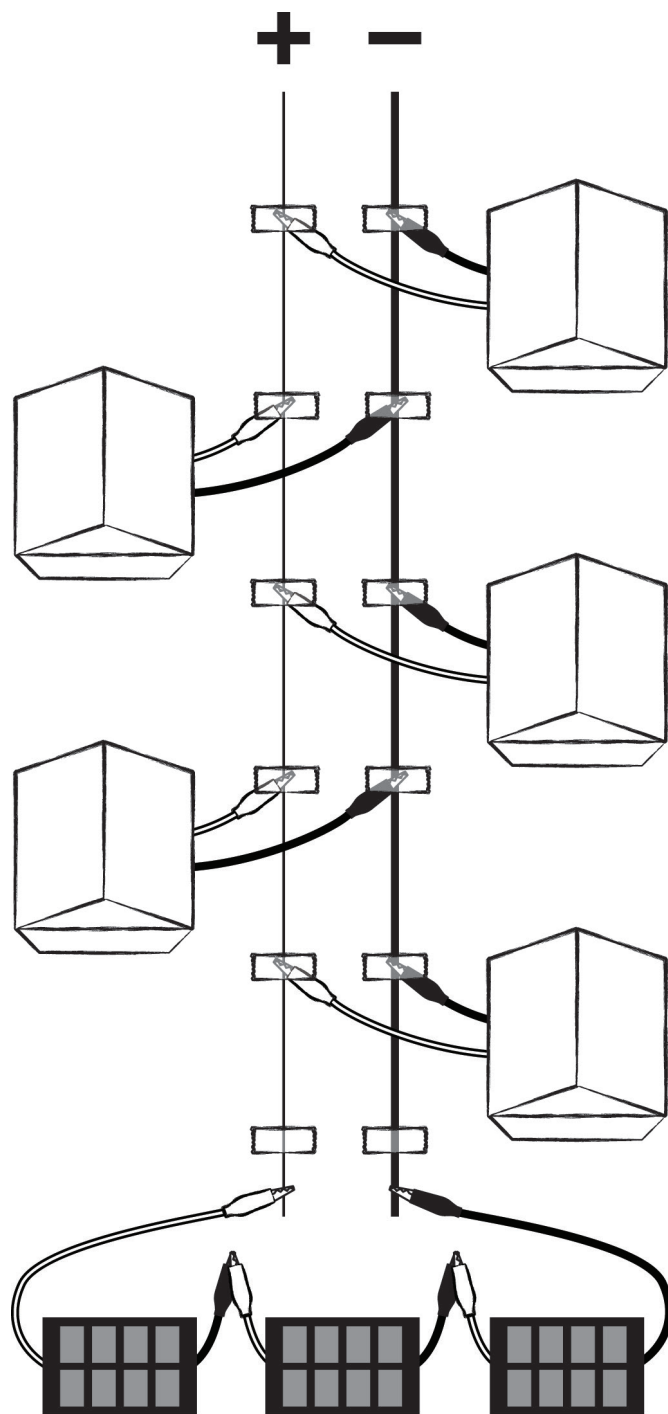
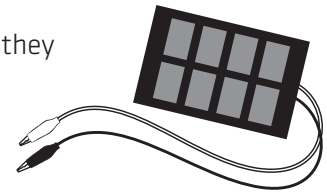

Fig. D

Solar Town

Vocabulary

We have called out some important vocabulary for students to understand as they work through the activities.



power source

The source from which electrons are sourced for a circuit. You must have a power source to have a working circuit.

switch

Something that controls the circuit, turning it on or off or giving it more or less power.

load

The work the power source has to do.

conductor

A material that allows for electricity to flow easily.

semi-conductor

A material that allows for electricity to flow, but not easily or efficiently.

insulator

A material that does not let electricity flow through it.

polarity

Designates the way electrons flow through any circuit - from negative to positive. Polarity is symbolized as a (+) or (-) sign, or red and black, respectively.

direct current (DC) circuit

A circuit in which one pole is always negative, the other pole is always positive, and the electrons flow from negative to positive.

alternating current (AC) circuit

A circuit in which the two poles alternate between negative and positive, alternating the flow of electrons each time.

voltage (V)

The amount of potential energy between two points on a circuit.

amperage (amps)

A measure of the current of a circuit, or the amount of electricity used.

series circuit

A circuit in which components are connected in a single path, like hands being held. In series, voltage changes and current remains consistent throughout.

parallel circuit

A circuit in which components are connected in parallel lines, like tracks on a railroad line. In parallel, current changes and voltage remains consistent throughout.

photovoltaic (PV)

Photovoltaic cells make up solar panels. The term comes from the words photo, meaning light, and volt, the measurement of electricity. They convert light directly into electricity.

Solar Panel Reading

Reading from Class Period 2.

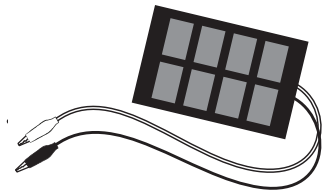

How does a solar panel work?

Given how prevalent solar panels are, it's surprising how little most people understand them. Give your students a brief overview of the process that happens inside each solar panel. Find a video or a diagram to supplement, recommended below. This will give students a more tangible understanding of how this can be used as an energy source.

Each solar panel is made up of tiny photovoltaic (PV) cells. Photovoltaic comes from the words *photo*, meaning light, and *volt*, the measurement of electricity. Photovoltaic cells convert light directly into electricity. PV technology works any time the sun is shining, but the most electricity is produced when the light is intense and when sunlight is striking the PV modules at a perpendicular angle, which is the most direct.

Sunlight is composed of photons, or bundles of radiant energy. When photons strike a PV cell, a fraction of them are absorbed, and the energy from these photons is transferred to electrons in the atoms of the solar cell. With their newfound energy, the electrons are able to escape from their normal positions associated with their atoms to become part

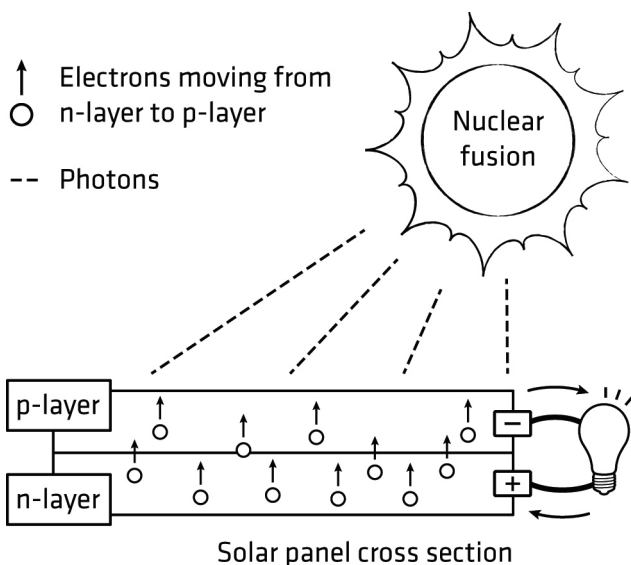

of the current in an electrical circuit. By leaving their positions, the electrons cause holes to form in the atomic structure of the cell into which other electrons can move, continuing the process.

Solar cells are usually made of two thin pieces of silicon, a semiconductor. One piece of silicon has a small amount of boron added to it, which gives it a tendency to attract electrons. It is called the P-Layer because of its positive tendency. The other piece of silicon has a small amount of phosphorous added to it, giving it an excess of free electrons. This is called

- ⊕ Protein
- ⊖ Tightly-held electron
- Free electron
- Can accept an electron

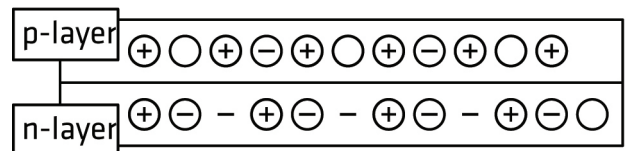

PHOTOVOLTAIC CELL CROSS SECTION

the N-Layer because it has a tendency to give up negatively charged electrons. When the two pieces of silicon are placed together, some electrons from the N-Layer flow to the P-Layer and an electric field forms between the layers. The P-Layer now has a negative charge and the N-Layer has a positive charge. When the PV cell is placed in the sun, the radiant energy energizes the free electrons. A circuit is made connecting the layers, forcing electrons to flow from the N-Layer through the wire to the P-Layer. The flow of electrons means the PV cell is now producing electricity!

Did you like the **Solar Town Class Pack**? Then you might be interested in these REcharge Labs classroom kits.

MacGyver Windmill Kit Class Pack

Students will use a limited amount of materials to design and build functioning windmill models. They will use these models to convert wind into mechanical energy in order to lift weights. Using the scientific method, they will conduct trials, change variables, and work to improve the performance of their windmills.

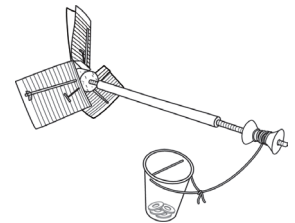

Firefly

This activity explores basic wind turbine design. Learn how to make an efficient wind turbine by designing a pinwheel shape to catch wind and illuminate an LED bulb. Experiment with materials and get creative with design.

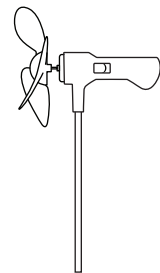

Sail Car Class Pack

Build a Sail Car using inexpensive materials to demonstrate how wind can be used to propel an object. Gather measurements, record changes in variables, and use simple engineering design concepts to build sails that can push the car as far as possible..

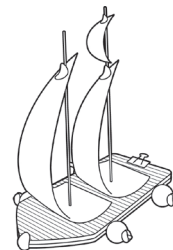

Solar Fountain Kit

Learn how to use the power of the sun to build a creative electrical fountain. Discover how solar panels work, learn basic circuitry, and use this knowledge to build a custom solar powered fountain.

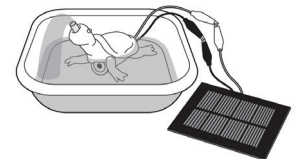

Visit www.rechargelabs.org for more.

2010 East Hennepin Ave Building #2, Suite 101

Minneapolis, MN 55413

Phone: 877-917-0079 | Fax: 208-485-9419 | Email: info@rechargelabs.org

© REcharge Labs 2014 All Rights Reserved